

# TEMPCO®

## RCR-600 Hybrid Recorder Dotting Type Recorder





# For safety using

Thank you for purchasing our CR06 Hybrid Recorder.

In order to this instrument to exhibit all of its functions effectively and correctly, read and understand this instruction manual thoroughly before using the instrument.

Don't use this product in any method not specification by manufacturer. The protective features of this product may be impaired if it is used in a method not specified in the operation manual.

The symbols below are used on this instrument for the cautioning information.

Symbols used on the instrument	
	This shows "Caution for handling". This symbol is used on the parts need to reference the instruction manual for saving human body and the instrument.
	This shows "Protective grounding". Be sure to provide protective grounding prior to operate this instrument.
	This shows "Risk of electric shock". This symbol is used on the parts, which has a risk of electric shock.

Be sure to observe the following warnings/cautions and those provided in the text in order to secure safety in handling the instrument.

## **WARNING**

### General

- (1) In order to prevent electric shock; be sure to disconnect this instrument from the main power source when wiring it.
- (2) When the effect on the system is expected by the error occurs due to external factors or failure the instruments, take precautions to ensure the overall safety of your system.
- (3) Take precautions to so that an alien substance does not get into the instruments aperture.

### Protective Grounding

- (1) In order to prevent an electric shock; be sure to provide protective grounding prior to turning on this instrument.
- (2) Do not cut a protective grounding conductor or disconnect protective grounding.

### Power Source

- (1) Make sure that the supply voltage for this instrument conforms to the voltage of the supply source.

Rated power voltage range	: 100-240VAC
Working supply voltage range	: 85-264VAC
Rated power frequency	: 50/60Hz
Power consumption	: 30VA max

- (2) Attach a protective cover prior to turning on this instrument.
- (3) Power module that is used in the instruments conform to EN60950

### Working Environment

- (1) Do not operate this instrument in the environment where it is exposed to a combustible/explosive/corrosive gas or water/steam.

- (2) Please use in an environment that is shown in the following.

Installation features	: Indoor
Altitude	: 2000m or less
Ambient temperature	: 0-50°C
Ambient humidity	: 20-80%RH(Non condensing)
Overvoltage category	: Category II
Allowable pollution degree	: Pollution degree 2
Vibration	: 10~60Hz 0.2m/s <sup>2</sup>
Impact	: The impact is not allowed.

### Input and Output Wiring

Provide input and output wiring after turning off the power.



## CAUTION

### Input and Output Wiring

Do not use empty terminals for other purposes such as relaying, etc.

### Inside of Instrument

Do not touch the switches, etc. inside this instrument. Also, do not replace the main unit or PRINTed circuit boards. When this is neglected, we cannot guarantee functioning of the instrument. Contact our dealer where you purchased the instrument, or our sales representative.

### Transportation

When transporting this instrument or the equipment with this instrument incorporated in it, take measures to prevent opening the door and falling out the inner module.

## [Note]

### Instruction Manual

- (1) Deliver this instruction manual to an end user.
- (2) Prior to handling this instrument, be sure to read this manual.
- (3) If you have any questions on this manual or find any errors or omissions in this manual, contact our sales representative.
- (4) After reading this manual, keep it carefully by the instrument.
- (5) When the manual is lost or stained, contact our sales representative.
- (6) It is prohibited to copy or reproduce this manual without our permission.

### Installation

- (1) When installing this instrument, put on a protective gear such as safety shoes, helmet, etc. for your safety.
- (2) Do not put your foot on the installed instrument or get on it, because it is dangerous.

### Maintenance

Only our serviceman or persons authorized by Tempco are allowed to remove and take the inner module, the main unit and PRINTed circuit boards apart.

### Disposal

- (1) Dispose the replaced batteries in a correct way.
- (2) Do not incinerate plastics of maintenance parts and replacement parts. A harmful gas may be produced.

### Cleaning

- (1) Use dry cloth to clean the surface of this instrument.
- (2) Do not use any organic solvent.
- (3) Cleaning the instrument after turning off the power.

### Revisions

This instruction manual is subject to change without prior notice.

# Using procedure for this manual

## 1.Using procedure

This instruction manual consists of “For safety using”, “Contents” and “Chapter 1 to Chapter 11” as bellow.



Read the applying sections for your purpose to use this instrument.

Chapter and TITLE	For purchase and install	For initial setting and change setting	For daily operation	For using communication	For maintenance and trouble-shooting
For safety using (page 1)	◎	◎	◎	◎	◎
1. INTRODUCTION	◎				
2. CONSTRUCTION	○	○	○		○
3. INSTALLATION	◎		○		
4. WIRING	◎	○	○	○	○
5. PREPARATIONS FOR OPERATION		○	◎		
6. OPERATION		○	◎		
7. DEVICE SETTING		◎		○	○
8.COMMUNICATIONS				◎	
9. MAINTENANCE					◎
10. TROUBLESHOOTING		○			◎
11. SPECIFICATIONS	○	○			○

◎ :Be absolutely certain to read this.

○ :Be certain to read this if you need.

The symbols below are used on the warning and cautioning information in this manual.

Symbols used on this manual	
 <b>WARNING</b>	Failure to observe this information could result in death or injury. Be absolutely certain to read this.
 <b>CAUTION</b>	Failure to observe this information could damage the instrument. Be certain to read it.
<b>[Note]</b>	This is cautionary information for correct use of the instrument. Be certain to read it.
<b>[Reference]</b>	This is information to help you use the functions of this instrument more effectively.

## 2.Guide of Instruction manual

The instruction manuals of this instrument are as the table below.

	Name	Part No.	Outline
This manual →	1 RCR-600 Hybrid Recorder (Dotting type) instruction manual	MANUAL RCR-600	Explanation for installing, wiring, standard operation. And setting or operation for using this instrument.
	2 RCR-600 Hybrid Recorder Communication Command instruction manual	COMMUNICATION MANUAL	Explanation for reading and writing data of the recorder by communication function.

# CONTENTS

<b>1. INTRODUCTION .....</b>	<b>6</b>	<b>7. DEVICE SETTING.....</b>	<b>42</b>
1.1 Checking the Accessories .....	6	7.1 Setting the Setup Mode.....	42
1.2 Checking the Type and Specifications .....	7	7.1.1 Setting the Range.....	45
1.3 Temporary Storage .....	8	(1) Setting method.....	45
1.4 Indication Card .....	8	(2) . . . . (Current/Voltage), . . (Thermocouple), . . . . (Resistance Temperature Detector) .....	46
<b>2. CONSTRUCTION.....</b>	<b>9</b>	(3) . . . . (Scaling).....	48
2.1 Appearance .....	9	(4) . . . . (Square Root).....	50
2.2 Display Screen and Operation Keys.....	10	(5) . . . . (Decade).....	52
2.2.1 Display Screen.....	10	(6) . . . . (Difference), . . . . (Sum), . . . . (Average) .....	54
2.2.2 Operation Keys .....	11	(7) . . . . (Skip).....	55
<b>3. INSTALLATION .....</b>	<b>12</b>	7.1.2 Setting the Alarm .....	56
3.1 Outside Dimensions Drawing and Panel Cutting Dimensions .....	12	7.1.3 Setting the Unit .....	58
3.2 Mounting to the Panel.....	13	(1) Character Code Table.....	59
3.2.1 Procedure for Mounting to the Panel.....	13	7.1.4 Setting the Chart Speed.....	60
3.2.2 Mounting to the Panel in compliance with the IP65 .....	14	7.1.5 Setting the Date and Time .....	61
<b>4. WIRING.....</b>	<b>15</b>	7.1.6 Copying the Setting Data .....	62
4.1 Terminal Layout and Power Wiring .....	15	7.1.7 Setting Other Functions.....	63
4.1.1 Terminal Layout.....	15	(1) . . . . (Printing Cycle).....	64
4.1.2 Power Wiring.....	15	(2) . . . . (Zone Recording).....	64
4.1.3 Wiring Procedure .....	16	(3) . . . . (Partial Compression/Expansion) .....	65
4.2 Input Wiring .....	17	(4) . . . . (Digital Print) .....	66
4.2.1 Wiring Procedure .....	18	(5) . . . . (Tag).....	67
4.3 DI/Alarm Output Wiring (Option) .....	20	(6) . . . . (Comment Words) .....	68
4.3.1 DI/Alarm Output Wiring Example.....	20	7.2 Setting the Engineering Mode .....	69
4.3.2 Alarm Output Wiring Procedure .....	21	7.2.1 Alarm Hysteresis .....	72
4.3.3 DI Wiring Procedure .....	21	7.2.2 Burnout ON/OFF .....	72
4.4 Communication Wiring .....	22	7.2.3 Channel Offset.....	72
4.4.1 RS-232C Wiring.....	22	7.2.4 Reference Junction Compensation.....	73
4.4.2 RS-485 Wiring.....	22	7.2.5 Changing the Printing Color .....	74
<b>5. PREPARATIONS FOR OPERATION .....</b>	<b>23</b>	7.2.6 Settings Related to Recording .....	75
5.1 Setting the Chart Paper .....	23	(1) Recording start/stop trigger setting.....	75
5.2 Setting the Ribbon Cassette.....	29	(2) Tag/channel print selection .....	75
<b>6. OPERATION .....</b>	<b>31</b>	(3) Alarm print ON/OFF.....	76
6.1 Operation.....	31	(4) Logging print ON/OFF .....	76
6.1.1 Status after Initial Screen .....	31	(5) Scale print ON/OFF .....	78
6.2 Recording .....	32	(6) Logging print Synchronous/Asynchronous .....	78
6.2.1 Recording Colors .....	32	7.2.7 Setting the Communication Function.....	79
6.3 How to Record .....	32	7.2.8 Initializing the Setup Data and Calibration Data.....	79
6.3.1 Starting/Stopping Recording Operation .....	32	7.2.9 DI Functions.....	80
6.3.2 Feed the Chart Paper .....	32	7.2.10 Temperature Unit.....	80
6.3.3 Print Sample.....	33	7.2.11 Point Calibration.....	81
6.4 Digital Print.....	34	7.2.12 Data Calibration .....	82
6.4.1 Manual Print .....	34	7.3 Terminating the Engineering Mode.....	84
6.4.2 List Print.....	35		
6.4.3 Engineering List Print.....	37		
6.4.4 Record Start/End Print .....	39		
6.4.5 DI Manual Print.....	39		
6.4.6 DI Date/Time Print.....	39		
6.4.7 DI Comment Print .....	40		
6.5 Changing the Display .....	41		
6.5.1 Auto Display < . . . >.....	41		
6.5.2 Manual Display < . . . >.....	41		
6.5.3 Date Display < . . . >.....	41		
6.5.4 Time Display < . . . >.....	41		
6.5.5 Display Off < . . . >.....	41		

<b>8. COMMUNICATIONS.....</b>	<b>85</b>	<b>10. TROUBLESHOOTING .....</b>	<b>102</b>
8.1 General Description .....	85	10.1 Troubleshooting .....	102
8.1.1 General Description of Functions.....	85	10.1.1 Trouble Items .....	102
8.1.2 Transmission Specifications .....	85	10.1.2 When the Recorder Dose not Work at All.....	102
8.2 Original Protocol.....	86	10.1.3 When there is a Big Error.....	103
8.2.1 Data Construction .....	86	10.1.4 When the Trend Recording Deflected.....	103
8.2.2 Opening/Closing the Link .....	86	10.1.5 When Records Nothing.....	104
8.2.3 Outputting the Process Variable Data.....	87	10.1.6 When Recording is Faint.....	104
8.2.4 Outputting the Unit and Decimal Point Position Data .....	90	10.1.7 When the Chart Paper is not fed at All .....	105
8.2.5 Outputting the Status .....	91	10.1.8 When the Chart Paper is not fed Properly .....	105
8.2.6 Data Reception Example.....	92	10.2 Self Diagnostics Function (ERROR) .....	106
8.3 Modbus RTU Protocol .....	93	10.2.1 Self Diagnostic Items.....	106
8.3.1 Data Construction .....	93	10.2.2 Error Display .....	107
8.3.2 Function Codes.....	93	<b>11. SPECIFICATIONS.....</b>	<b>108</b>
8.3.3 Error Response.....	93	11.1 Common Specifications.....	108
8.3.4 Reading from the Input Register Area .....	94	11.1.1 Input Signal .....	108
8.3.5 Reading from or Writing to the Holding Register Area .....	97	11.1.2 Performance and Characteristics .....	108
<b>9. MAINTENANCE .....</b>	<b>98</b>	11.1.3 Structure .....	109
9.1 Inspection .....	98	11.1.4 Power Source .....	109
9.2 Cleaning .....	98	11.1.5 Normal Operating Conditions.....	109
9.3 Replacing Consumables .....	99	11.1.6 Alarm (Relay Output is Optional) .....	110
9.4 Adjust Dot Printing Position (Point Calibration).....	99	11.1.7 Safety Standard and EMI Standard .....	110
9.5 Calibration (Data Calibration) .....	99	11.1.8 DI Function (Option) .....	110
(1) Calibration of Voltage .....	100	11.1.9 Paper-empty Detecting Function (Option).....	110
(2) Calibration of Resistance Temperature Detector.....	100	11.2 Standard Setting Specifications.....	111
(3) Calibration of Reference Junction Compensation.....	101	11.2.1 Measurement Range .....	111
		11.2.2 The Accuracy at the Computation.....	114
		(1) Scaling.....	114
		(2) Square Root Computation .....	114
		(3) Decade.....	115
		(4) Difference, Sum, and Average .....	115
		11.2.3 Individual Specifications.....	116
		11.2.4 Standard Functions.....	117
		11.3 Standard Setting Functions .....	118
		11.3.1 Standard Setting Functions .....	118
		11.4 Optional Functions.....	118
		11.4.1 Remote Function of DI .....	118
		11.4.2 Alarm Board .....	118
		11.4.3 Communication Unit.....	118

# 1. INTRODUCTION

## 1.1 Checking the Accessories

Upon delivery of this instrument, unpack and check its accessories and appearance.

If there are any missing accessories or damages on the appearance, contact our dealer where you purchased the instrument, or our sales representative.

Following accessories should be attached.

① Chart paper

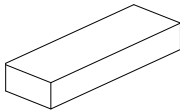

② Ribbon cassette

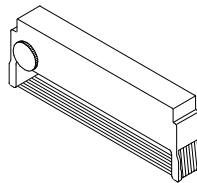

③ Mounting bracket

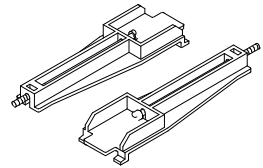

④ Instruction manual

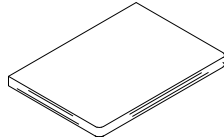

⑤ Packing

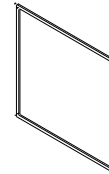

Fig. 1.1 Accessories

Table 1.1 List of Accessories

No.	Part Name	Type	Quantity	Remarks
1	Chart paper	RCA40901	1	50 equal divisions
2	Ribbon Cassette	RCA40902	1	
3	Mounting bracket		2	Panel mounting bracket
4	Instruction manual		1	This manual
5	Packing		1	For IP65

### [Note]

The ribbon cassette has been set in the instrument upon shipment.

## 1.2 Checking the Type and Specifications

A nameplate is affixed to the inside of the instrument. Remove the chart holder and make sure that the nameplate is affixed to the middle far side of the instrument.

Make sure that this instrument meets your requested specification, seeing the following tables.

**Table 1.2 Type**

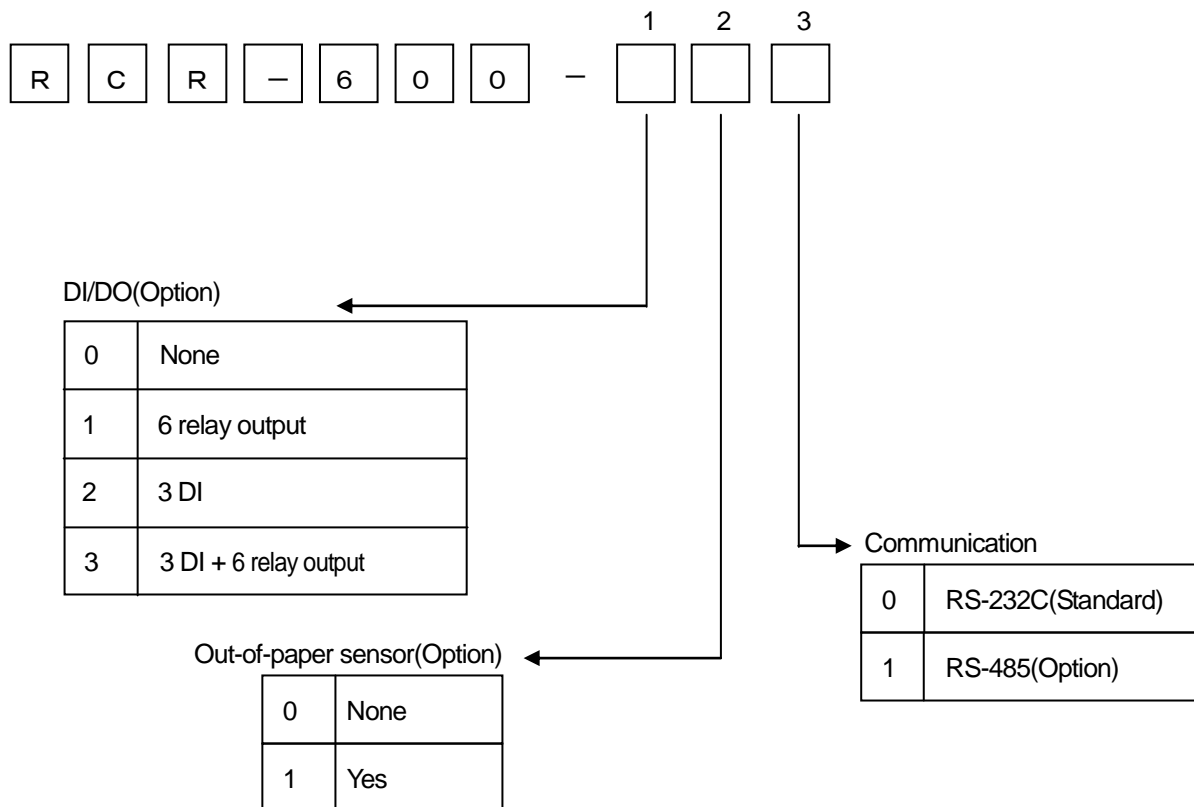



### 1.3 Temporary Storage

Store the instrument in the following environment.

When incorporated in the equipment, store it in the following environment as well.



#### CAUTION

Storage in a poor environment may damage the appearance, functions, and service life of the instrument.

##### Storage Environment

- A place with little dust.
- A place free from combustible, explosive, or corrosive gases ( SO<sub>2</sub>, H<sub>2</sub>S, etc. ).
- A place free from vibrations or shocks.
- A place free from water or steam or high humidity (95% RH max.).
- A place free from direct sunshine or high temperature ( 50°C max. ).
- A place free from an extremely low temperature ( -20°C min. ).

### 1.4 Indication Card

An indication card has been affixed to the door upon delivery. Enter a name as required.



#### CAUTION

Note that if a non-original nameplate is attached, it may damage the door or mounting part.

## 2. CONSTRUCTION

### 2.1 Appearance

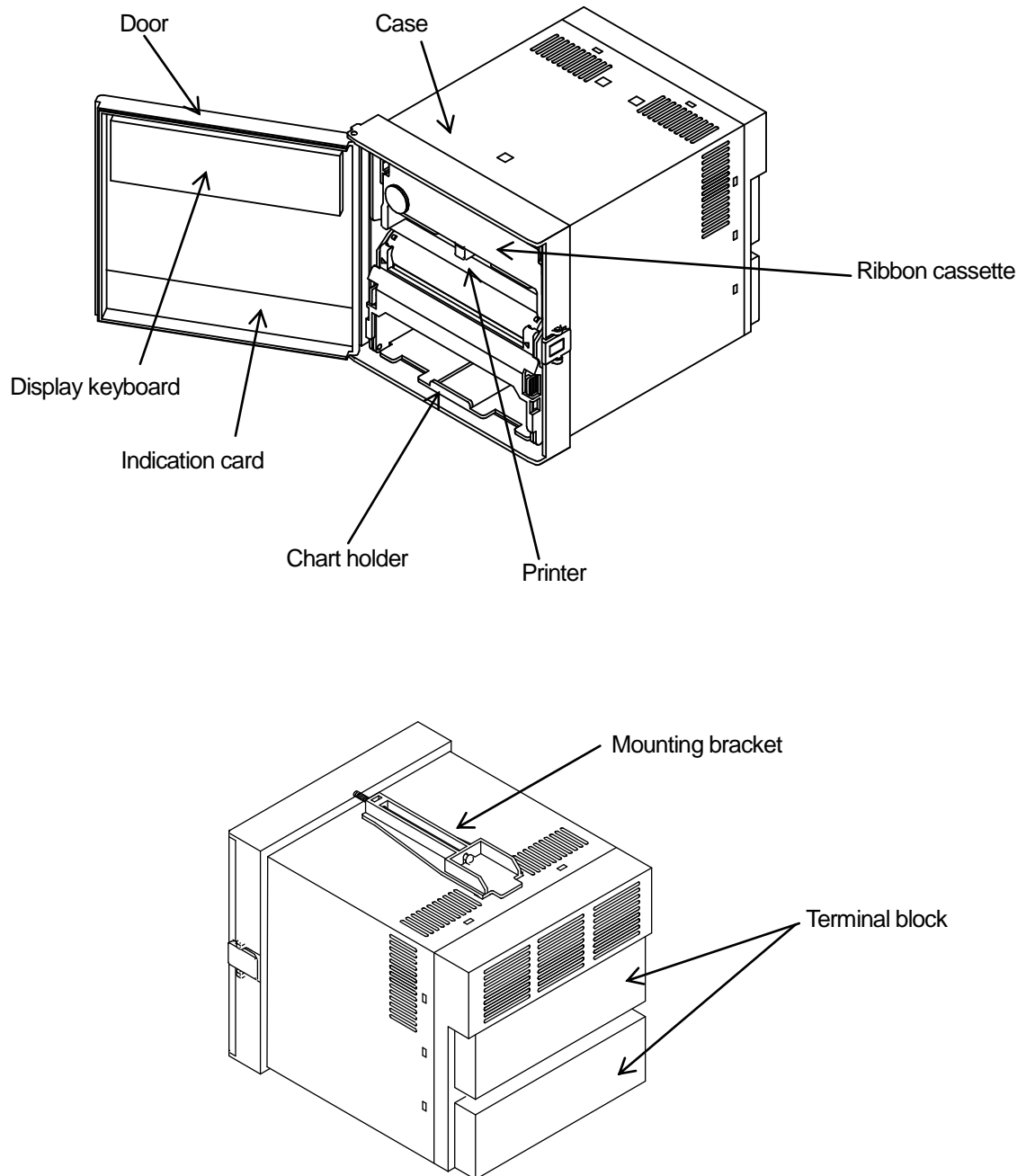

Fig. 2.1 Appearance

## 2.2 Display Screen and Operation Keys

### 2.2.1 Display Screen

The following describes the display screen. Since the channel numbers and data are indicated by a 7-segment LED, alphabets are symbolized to represent them.

For the LED display, see "Symbolized Alphabets for Display" at [Reference] below.

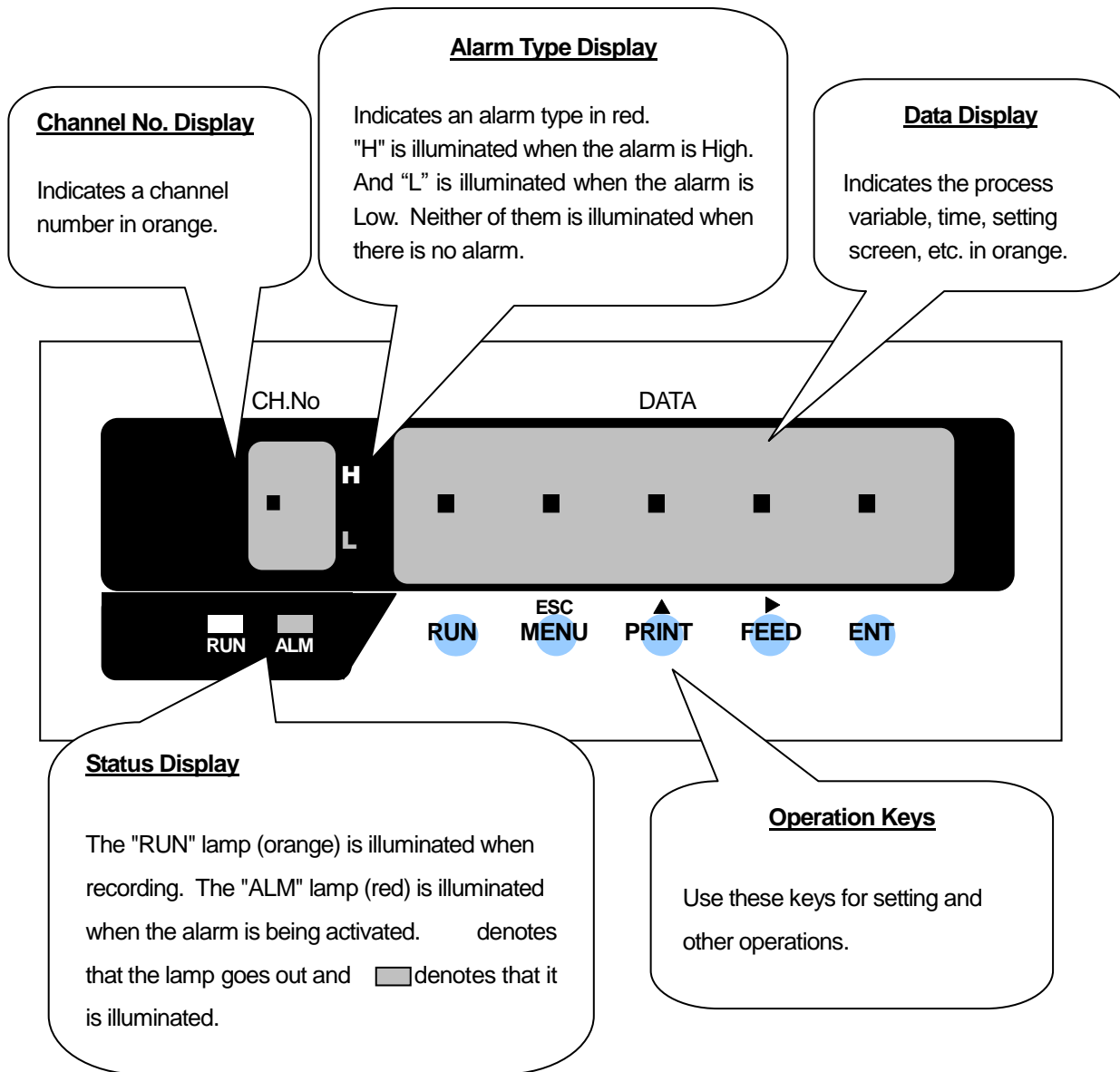

Fig. 2.2 Display

### [Reference] Symbolized Alphabets for Display

Display	•	•	•	•	•	•	•	•	•	•	•	•	•
Alphabet	A	B	C	D	E	F	G	H	h	I	J	K	L
Display	•	•	•	•	•	•	•	•	•	•	•	•	•
Alphabet	M	N	O	P	Q	R	S	T	U	V	W	X	Y

## 2.2.2 Operation Keys

The following describes each operation key.

This manual represents the actual operation keys as shown in the figure below.

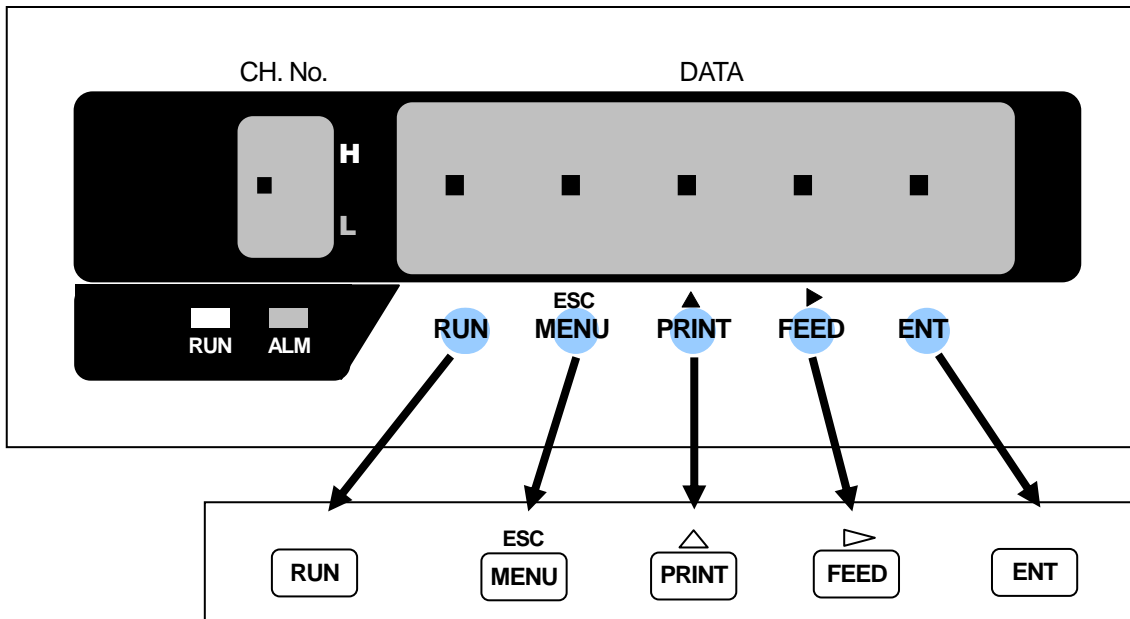

Fig. 2.3 Actual Display and Operation Keys

Table 2.1 Names of Operation Keys and Their Functions

Key	Name	Function	
	"RUN" key	Starts/stops recording. To stop, hold down the "RUN" key for 3 seconds or more. (Gone out the "RUN" lamp.) To start, press the "RUN" key. (Illuminates the "RUN" lamp.)	
	"MENU" key	MENU function	Selects engineering list print and change to the setting mode.
	"ESC" key	ESC function	Exits that menu halfway selecting a function.
	"PRINT" key	PRINT function	Used to perform manual print or list print.
	"Δ" key	Δ function	Used to select a setting parameter (numeral or built-in command)(ascending direction).
	"FEED" key	FEED function	The chart paper is fed while the key is pressed, and stopped when released.
	"·" key	· function	Used to shift a digit in setting a numeral.
	"ENT" key	Used for registering a setting parameter (numeral or built-in command) after selecting it, or executing a function. Pressing this key executes the setting.	

# 3. INSTALLATION

## 3.1 Outside Dimensions Drawing and Panel Cutting Dimensions

Unit: mm

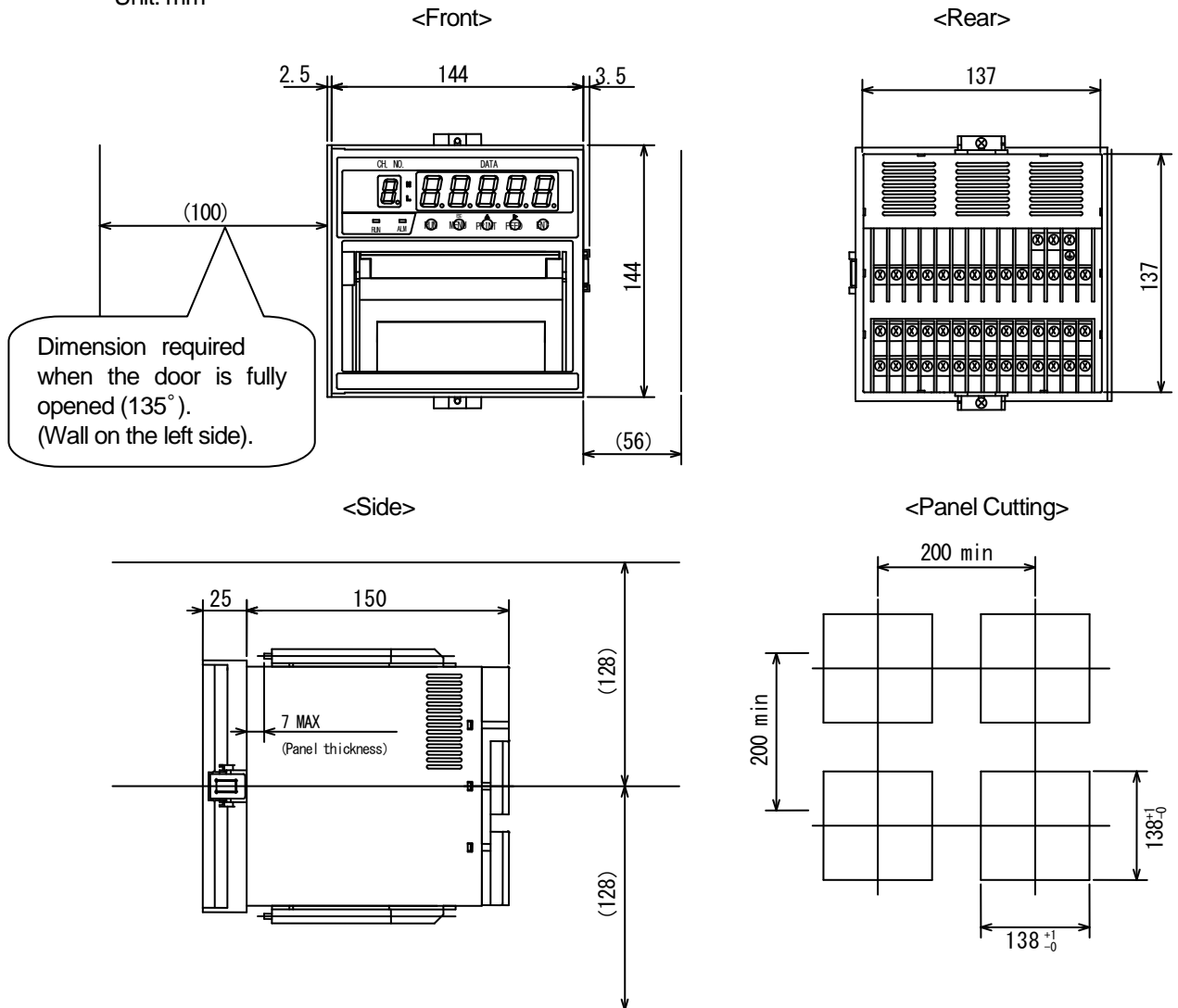

Fig. 3.1 Outside Dimensions and Panel Cutting Dimensions



### CAUTION

For maintenance and safety of the instrument, it is recommended to secure the spacing larger than the parenthesized dimensions per unit.

## 3.2 Mounting to the Panel



### WARNING

Do not install the instrument in a place exposed to a combustible, explosive, or corrosive gas ( $\text{SO}_2$ ,  $\text{H}_2\text{S}$ , etc.).



### CAUTION

#### Install the instrument in the following places

- A place free from where humidity often changes.
- A place of normal temperature ( $25^\circ\text{C}$  or so).
- A place exposed to as little mechanical vibrations as possible.
- A place with as little dusts as possible.
- A place affected by the electromagnetic field as little as possible.
- A place not directly exposed to high radiant heat.
- A place where the altitude is up to 2000m.
- Humidity has an effect on the chart paper and ink. Use the instrument in a humidity range of 20 to 80%RH (60%RH is optimum).
- This instrument needs the inside installation.

#### Mounting to the Panel

- A steel plate not thinner than 1.2mm is recommended as a mounting panel.
- The maximum thickness of the mounting panel is 7mm.

#### Inclination

- Install the instrument horizontally.
- The instrument should be installed so that its inclination should be  $0^\circ$  at the front and within  $30^\circ$  at the rear.

### 3.2.1 Procedure for Mounting to the Panel

- 1) Assemble the mounting bracket refer to Fig.3.2.
- 2) Fit in this instrument through the front of the panel.
- 3) Fit the claws of the mounting bracket into the square holes in the top and bottom surfaces of the case.
- 4) Tighten the screw of the mounting bracket with a screwdriver to attach it to the panel. When the mounting unit does not move back and forth any more, tighten a screw by  $180^\circ$ .

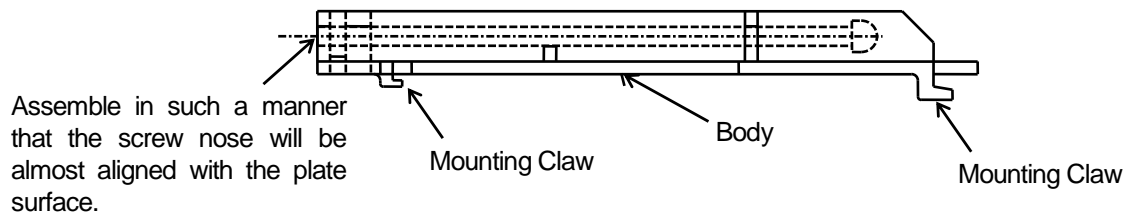
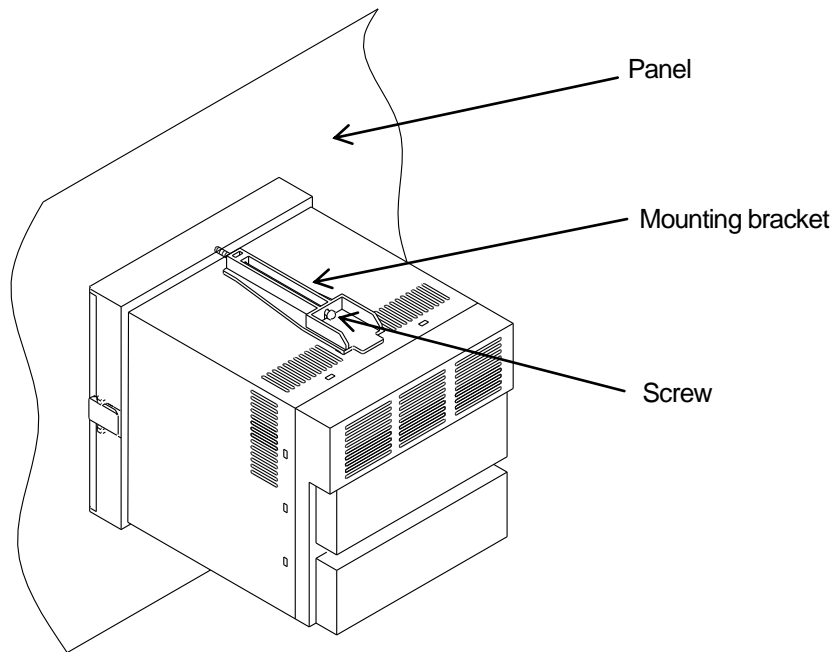

Fig. 3.2 Mounting bracket

### [Note]

If it is tightened with an excessive force, the case may be distorted and the mounting bracket may be deformed. An adequate tightening torque is about  $0.2$  to  $0.3 \text{ N}\cdot\text{m}$  ( $2\sim3 \text{ kgf}\cdot\text{cm}$ ).



**Fig. 3.3 Mounting to the Panel**

**3.2.2 Mounting to the Panel in compliance with the IP65**

Prior to mounting the instrument to the panel, attach a packing to the position shown in the figure. The rest of the procedure is the same.

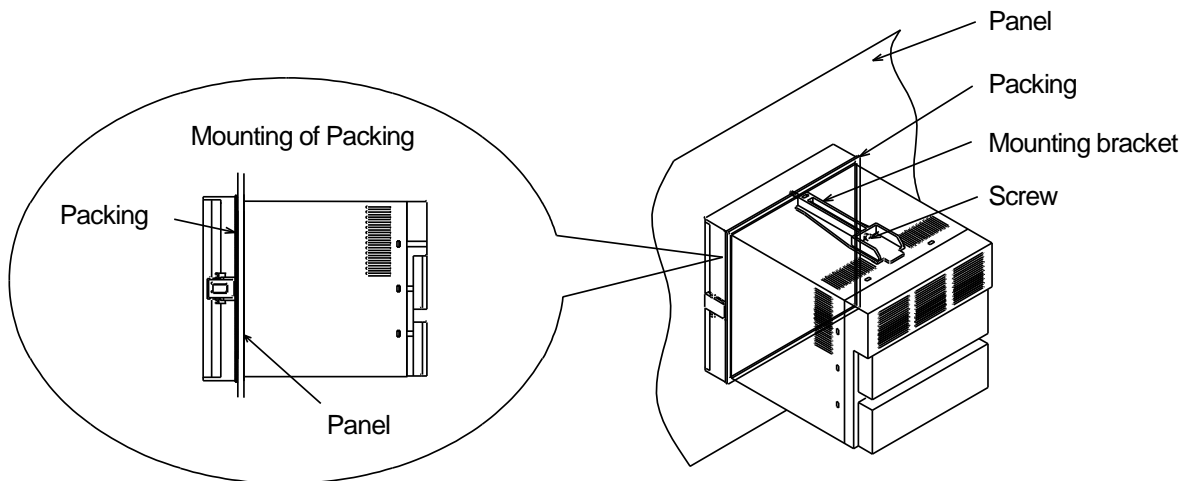

**Fig. 3.4 Mounting to the Panel (in compliance with the IP65)**

## 4.1 Terminal Layout and Power Wiring

### 4.1.1 Terminal Layout

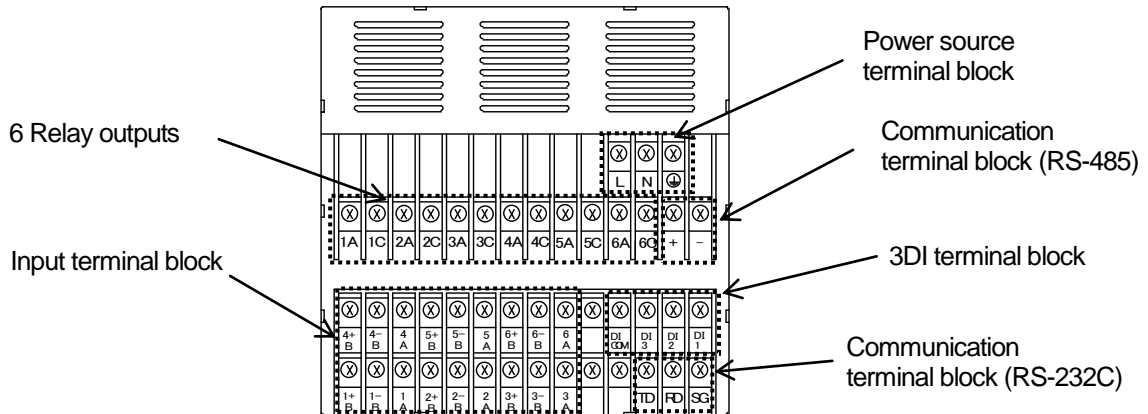

Fig. 4.1 Terminal Layout (Rear view)

### 4.1.2 Power Wiring



## WARNING

- ① In order to prevent an electric shock, be sure to provide protective grounding prior to turning on the instrument.
- ② Do not cut a protective grounding conductor or disconnect protective grounding.
- ③ Make sure that the supply voltage for the instrument conforms to the voltage of the supply source.
- ④ Attach a transparent protective cover prior to turning on the POWER of the instrument.
- ⑤ Any interruption of the protective conductor inside or outside the apparatus or disconnection of the protective grounding terminal is likely to make the apparatus dangerous under some fault conditions. Intentional interruption is prohibited.





## CAUTION

- ① As an electric wire for the power source, use a 600 V vinyl insulated wire (IEC60227-3) or its equivalent or above.
- ② Attach a round press-fitting terminal with insulated sleeve (for M3.5) to the end of the electric wire.
- ③ Connect a protective grounding (resistance:100Ω or lower, a minimum diameter of a grounding conductor:1.6mm) to the protective grounding terminal.
- ④ If other instrument shares the protective grounding conductor, there may be an effect caused by noise coming from the grounding conductor. It is recommended not to share it with other instrument.
- ⑤ In order to comply with the requirements of safety standard EN61010-1, the recorder shall have one of the following as a disconnecting device, fitted within easy reach of the operator, and labeled as the disconnecting device.
  - a. A switch or circuit breaker which complies with the requirements of IEC60947-1, IEC60947-3.
  - b. A separable coupler which can be disconnected without the use of a tool.
  - c. A separable plug, without a locking device, to mate with a socket outlet in the building.
- ⑥ This product has designed to conform to EN61010-1 installation Category II and pollution degree 2.
- ⑦ Please use the main power supply by the change within 10% of the rated voltage.
- ⑧ Transitional current might flow to the main power supply when the power supply is turned on.

### 4.1.3 Wiring Procedure



## CAUTION

The transparent protective cover should surely remove the left and right (both sides) hooks simultaneously. If it removes by turns, there is a possibility that it may damage.

- 1) Put your fingers on the left and right (both sides) hooks of the transparent protective cover on the power source terminal block. Pushing them inside, take out the cover to this side.
- 2) Connect the power source electric wire refer to Fig. 4.2. Connect the protective grounding to the  terminal. Connect the non-grounding side of the power source to "L" terminal. Connect the grounding side to the "N" terminal.
- 3) Put back the transparent protective cover.
- 4) Make sure that protective grounding is properly provided.

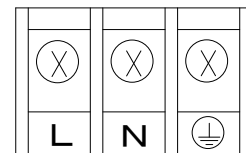

Power supply voltage

Rated power voltage range : 100-240VAC

Working supply voltage range : 85-264VAC

Rated power frequency : 50/60Hz

**Fig. 4.2 Power source Terminal block**

## 4.2 Input Wiring



### CAUTION

#### ① Precautions for the input electric wire

- See that no noise is mixed in input wiring. For input wiring, it is recommended to use a shielding wire or twisted wire effective for noise.
- In case of thermocouple input, connect a thermocouple wire directly or use a compensating lead wire. It is recommended to use a shielded input line.
- In case of resistance temperature detector input, dispersion of 3-wire line resistance should be less than the below mentioned values. It is recommended to use a shielded input line.  
For Pt 100, JPt 100 ; 50m $\Omega$  max.
- When it is likely to be affected by induction noise, particularly when wiring near the high-frequency power source, it is recommended to use a shielded twisted wire.
- Attach a round press-fitting terminal with insulated sleeve (for M3.5) to the end of the electric wire.

#### ② Precautions for wiring

- The wiring between the instrument and measurement point should be kept away from the power circuit (25V or higher circuit or DO circuit).
- Short-circuit unused input terminals. (Short-circuit between "+" and "-" in case of mV, V, or thermocouple input, and short-circuit among A, B, and B in case of resistance temperature detector input.)
- Ground the shield of connecting wire.

### 4.2.1 Wiring Procedure

#### **CAUTION**

The transparent protective cover should surely remove the left and right (both sides) hooks simultaneously. If it removes by turns, there is a possibility that it may damage.

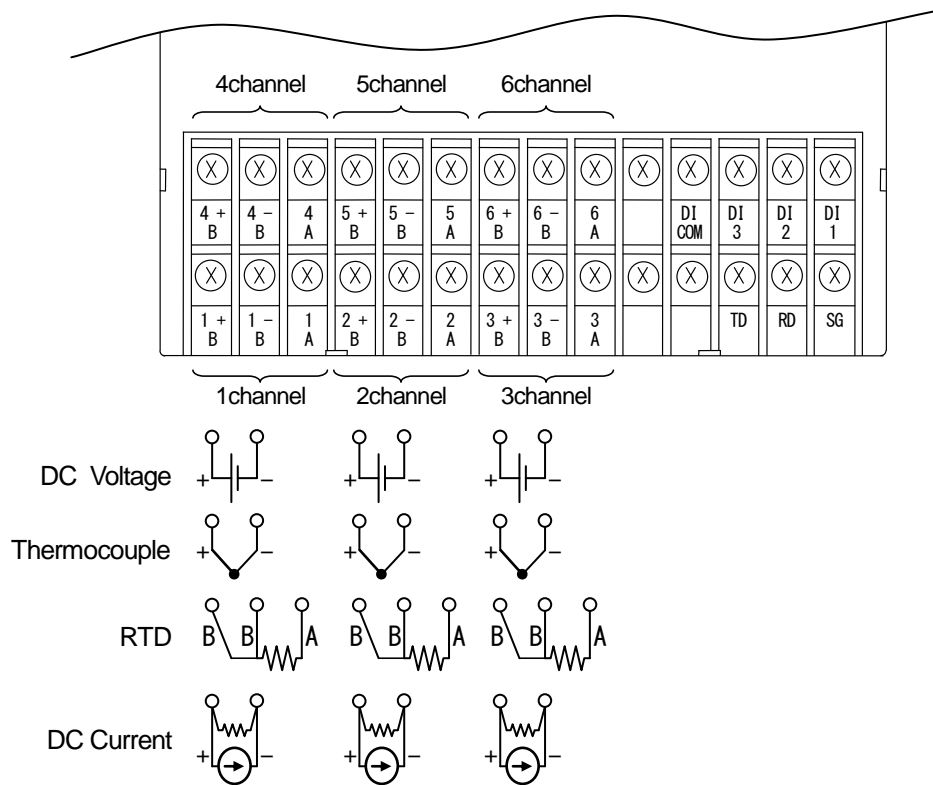

**Fig. 4.3 Input Wiring**

- 1) Put your fingers on the left and right (both sides) hooks of the transparent protective cover on the input terminal block. Pushing them inside, take out the cover to this side.
- 2) Wire the input lines refer to Fig. 4.3, Fig. 4.4(Page 18) and Fig. 4.5.(Page 19)
- 3) Put back the transparent protective cover.

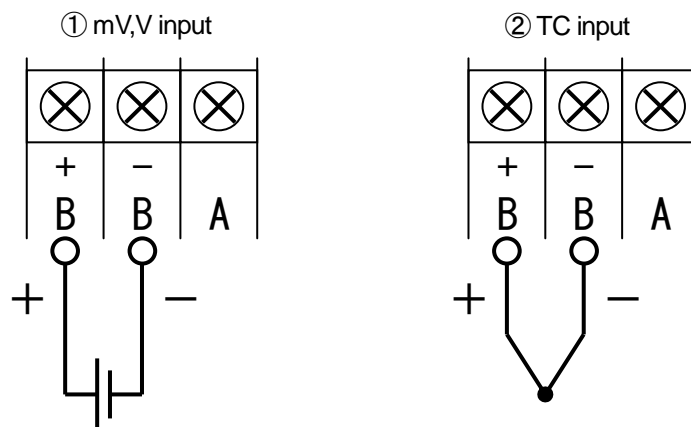

**Fig. 4.4 Input Wiring (mV, V, TC)**

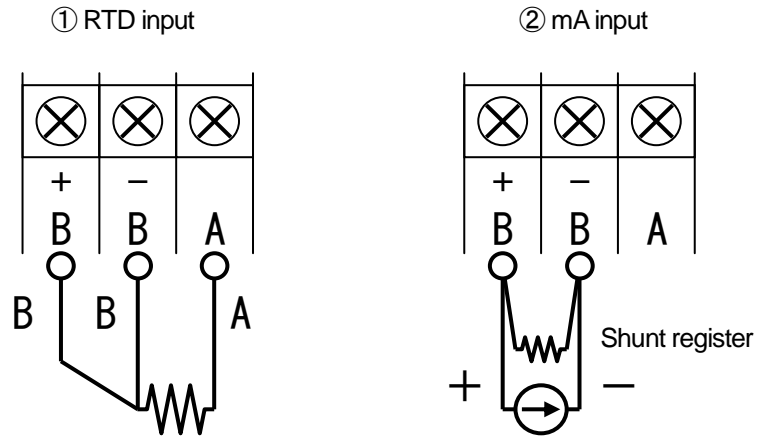

Fig. 4.5 Input Wiring ( RTD,mA )



**CAUTION**

- ① Attach the shunt resistor to the input terminal block of the instrument.
- ② Input accuracy is effected with the shunt resistor. Use the following recommended resistor.  
Resistance : 250Ω , Rated power : 1/4W, Tolerance : ±0.1% max.  
Temperature coefficient : ±50ppm max.

### 4.3 DI/Alarm Output Wiring (Option)

#### **! WARNING**

- ① Be sure to wire after turning off the POWER.
- ② When the power source has been connected to the Alarm output, turn off that power source.
- ③ When a hazardous voltage supplies to alarm terminal:
  - a) Never touch terminals preventing from electric shock.
  - b) Attach covers to terminals.
  - c) Wires should be double shielded.
  - d) Adopts round pressure terminal connectors with insulation cover for wire, preventing from lose connection.

#### **! CAUTION**

##### Precautions for Wiring the DI

- ① DI input has the built-in drive power source. Do not apply a voltage to a DI input terminal from the outside.
- ② A DI input contact capacity should be a withstand voltage of 50V DC, 16mA or more, ON resistance of 20Ω max.(Wiring resistance included).
- ③ Do not use unused terminals as relay terminals.

##### Precautions for Wiring the Alarm Output

- ① An alarm output contact capacity is as follows :
 

250VAC :	3A at maximum (Resistive load)
30VDC :	3A at maximum (Resistive load)
125VDC :	0.5A at maximum (Resistive load)
	0.1A at maximum L/R= 7ms at maximum (Inductive load)
- ② Attach an anti-surge protective circuit (surge absorbers, etc.) to an output terminal, as required.
- ③ Attach a round press-fitting terminal with insulated sleeve (for M3.5) to the end of an electric wire.
- ④ Keep alarm output wiring away from input wiring.
- ⑤ Do not use unused terminals as relay terminals.

#### 4.3.1 DI/Alarm Output Wiring Example

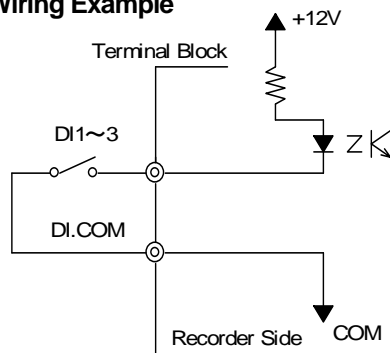

Fig. 4.6 DI Wiring Example

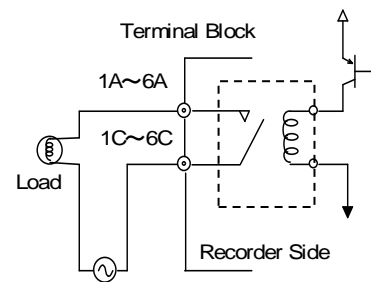

Fig. 4.7 Alarm Output Wiring Example

**CAUTION**

- ① The DI (Option) consists of a combination of 3 Digital inputs. The alarm output consists of 6-Relay output (Normally open).
- ② Relay No.1 is a common output of paper empty sensor (Option) and alarm.

**4.3.2 Alarm Output Wiring Procedure**

Wire the Alarm output refer to Fig.4.8.

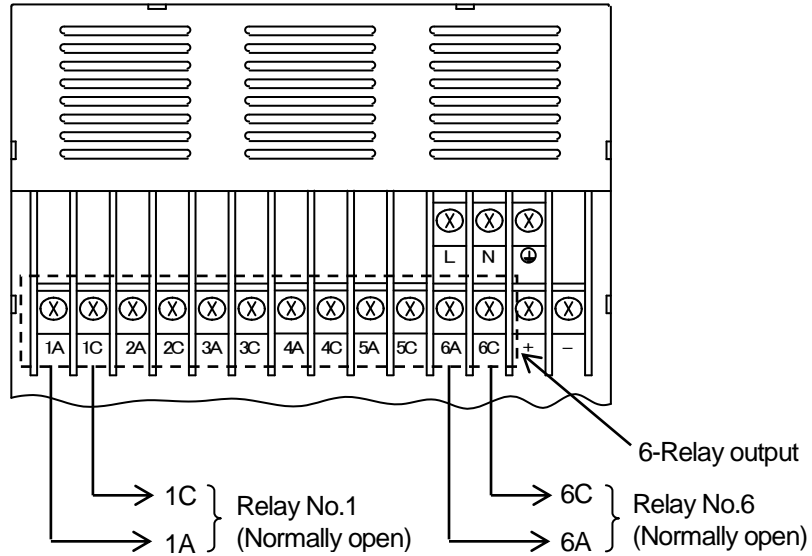

**Fig. 4.8 Alarm Output Wiring**

**4.3.3 DI Wiring Procedure**

Wire the DI refer to Fig.4.9.

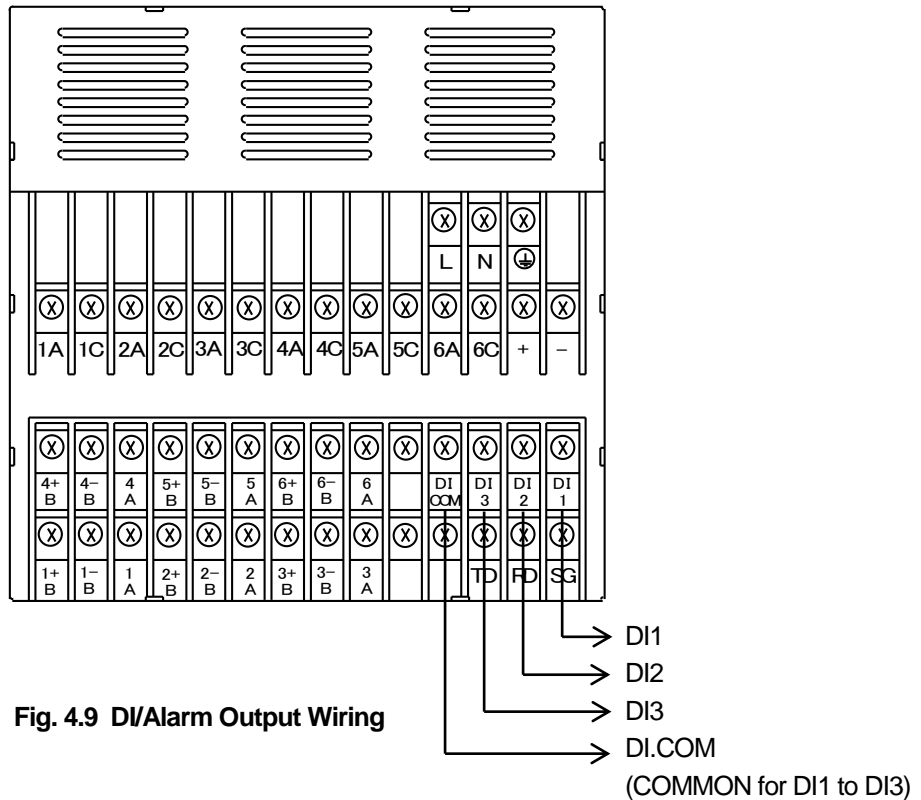

**Fig. 4.9 DI/Alarm Output Wiring**

## 4.4 Communication Wiring



### CAUTION

Precautions for the communication wiring

- ① See that no noise is mixed in communication wiring. For communication wiring, it is recommended to use a shielding wire effective for noise.
- ② When it is likely to be affected by induction noise, particularly when wiring near the high-frequency power source, it is recommended to use a shielded twisted wire.
- ③ Attach a round press-fitting terminal with insulated sleeve (for M3.5) to the end of the electric wire.
- ④ Ground the shield of a connecting wire.

### 4.4.1 RS-232C Wiring

Wire RS-232C refer to Fig.4.10.

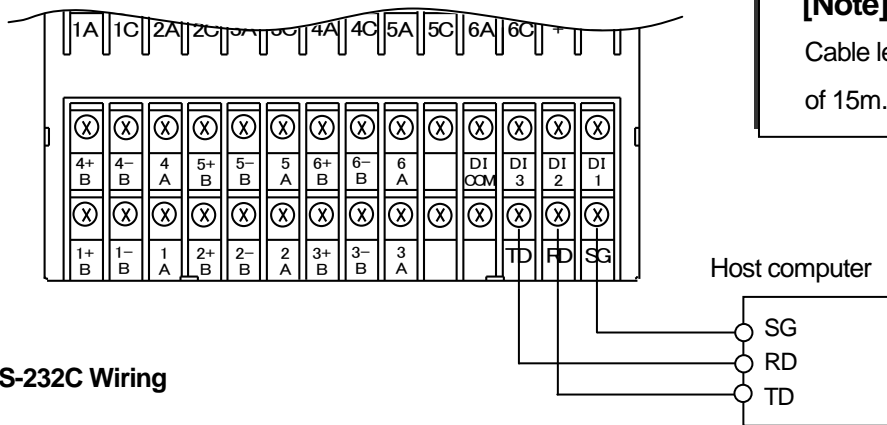

#### [Note]

Cable length is a maximum of 15m.

Fig. 4.10 RS-232C Wiring

### 4.4.2 RS-485 Wiring

Wire RS-485 refer to Fig.4.11.

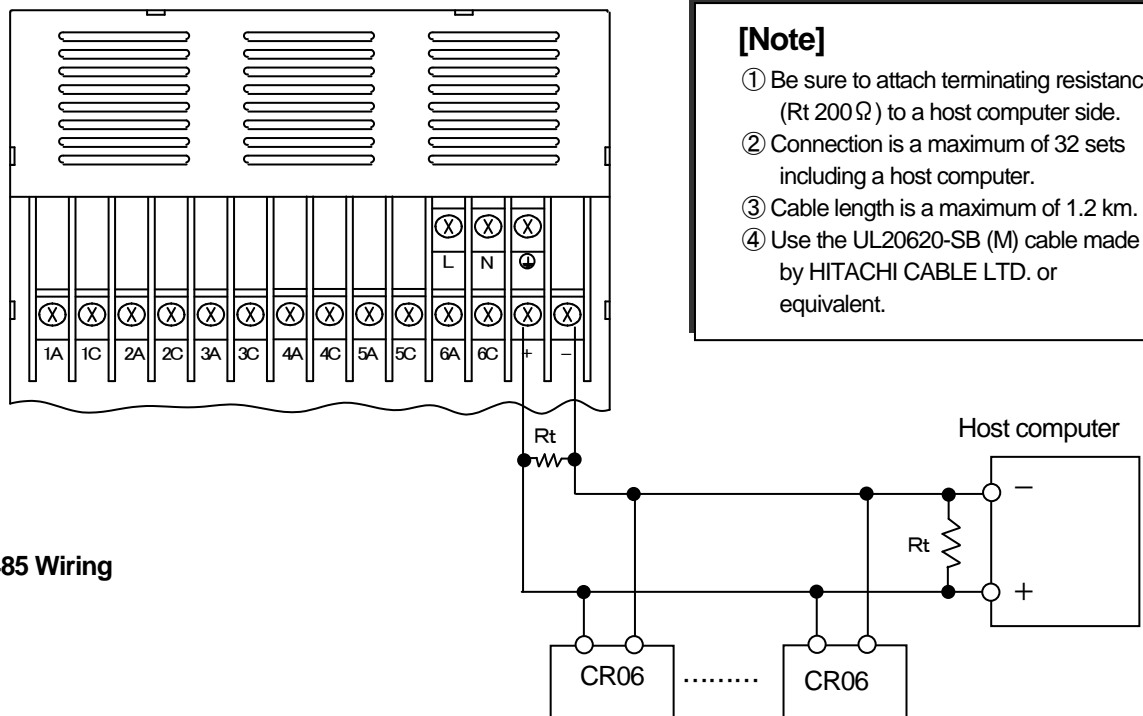

#### [Note]

- ① Be sure to attach terminating resistance ( $R_t$  200  $\Omega$ ) to a host computer side.
- ② Connection is a maximum of 32 sets including a host computer.
- ③ Cable length is a maximum of 1.2 km.
- ④ Use the UL20620-SB (M) cable made by HITACHI CABLE LTD. or equivalent.

Fig. 4.11 RS-485 Wiring

# 5. PREPARATIONS FOR OPERATION

## 5.1 Setting the Chart Paper

### CAUTION

It is recommended to use our original chart paper to ensure proper recording. If the chart paper holder is taken out with recording operation being activated, the ink ribbon may be damaged. To replace the chart paper, be sure to press the “RUN” key to stop recording.

(1) Pressing the “RUN” key for 3 seconds or more

Stop recording operation. With the power turned on, press the “RUN” key for 3 seconds or more.

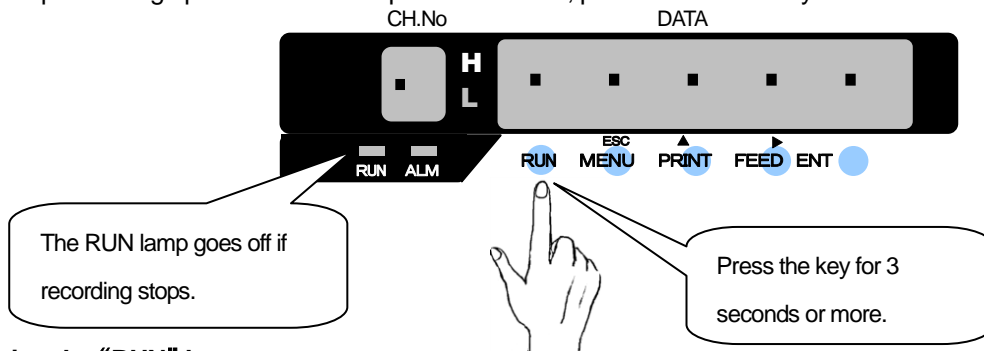

Fig. 5.1 Pressing the “RUN” key

(2) Opening the Door

### WARNING

Because you may be hurt when you put fingers at the time of the opening and closing of the door, please be careful.

### CAUTION

Maximum angle of the door in opened-state is 135 degree. Do not further open the door otherwise hinge will be broken.

Push the door hook to unlock the door. Pull the door to this side to open it.

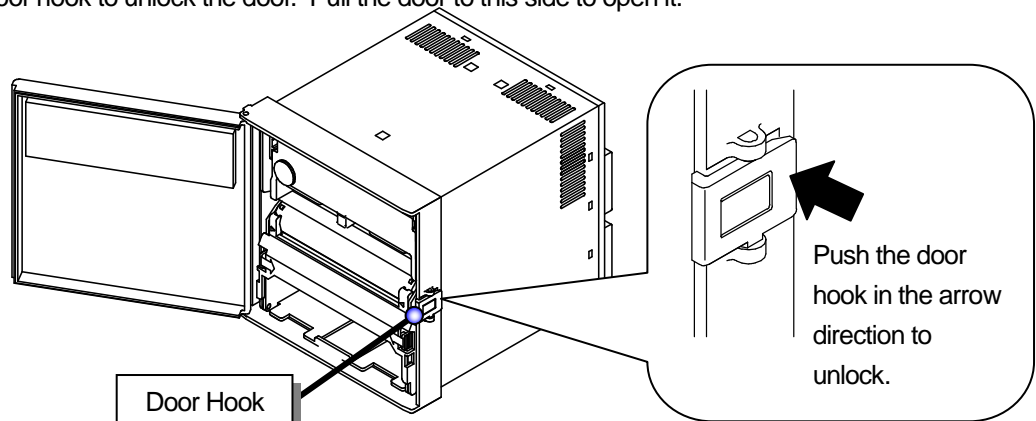

Fig. 5.2 Opening the Door



(3) Taking out the Chart Holder

Put your fingers onto the levers at both sides of the chart holder and pull it out to this side.

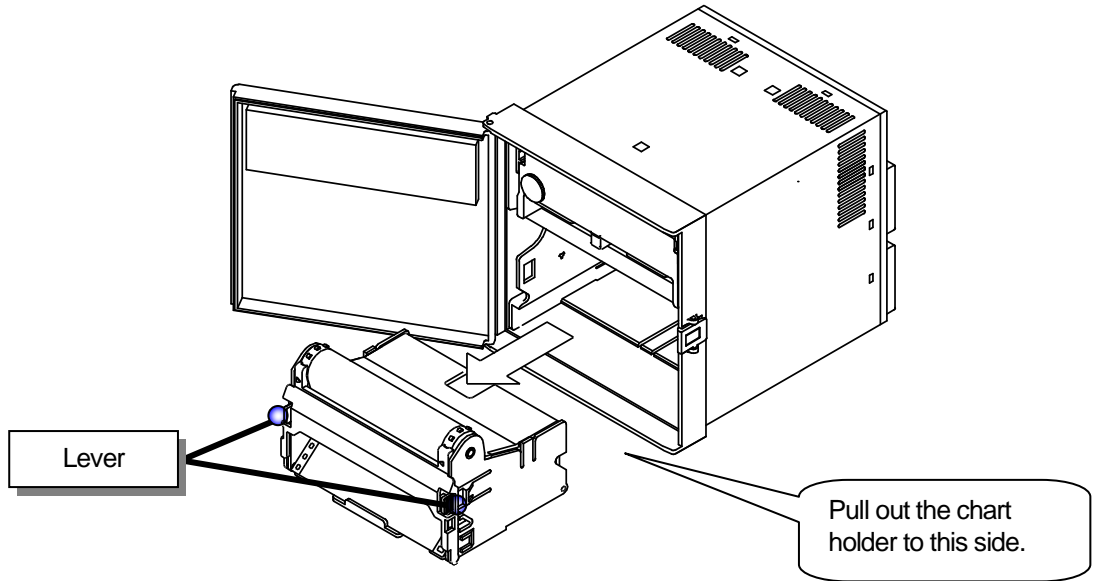

Fig. 5.3 Taking out the Chart Holder

(4) Opening the Chart Cover and Chart Guide

Open the chart guide and the chart cover outwardly.

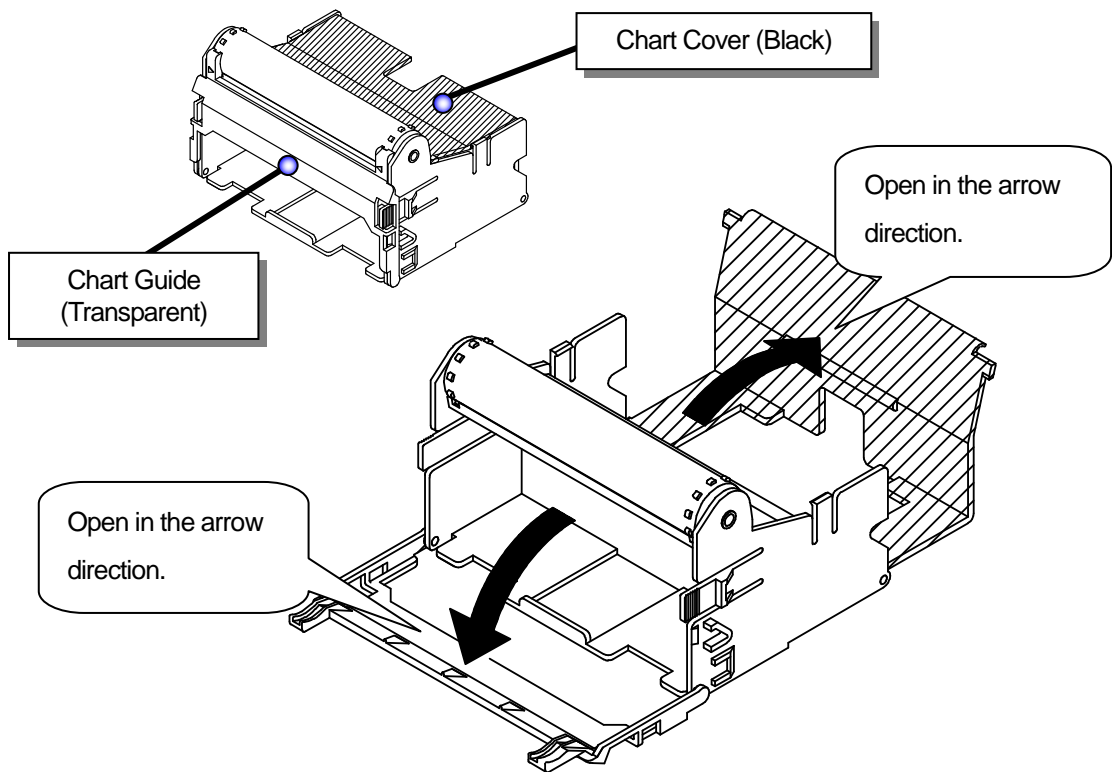

Fig. 5.4 Opening the Chart Cover and Chart Guide

(5) Loosening the chart paper

The chart paper may not be proper fed, if it is stuck at perforations. Be sure to loosen the paper.



**Fig. 5.5 Loosening the Chart Paper**

(6) Setting the Chart Paper into the Storage Chamber

Unfold the chart paper by two plies. Holding the printing surface upward, set it in the storage chamber.

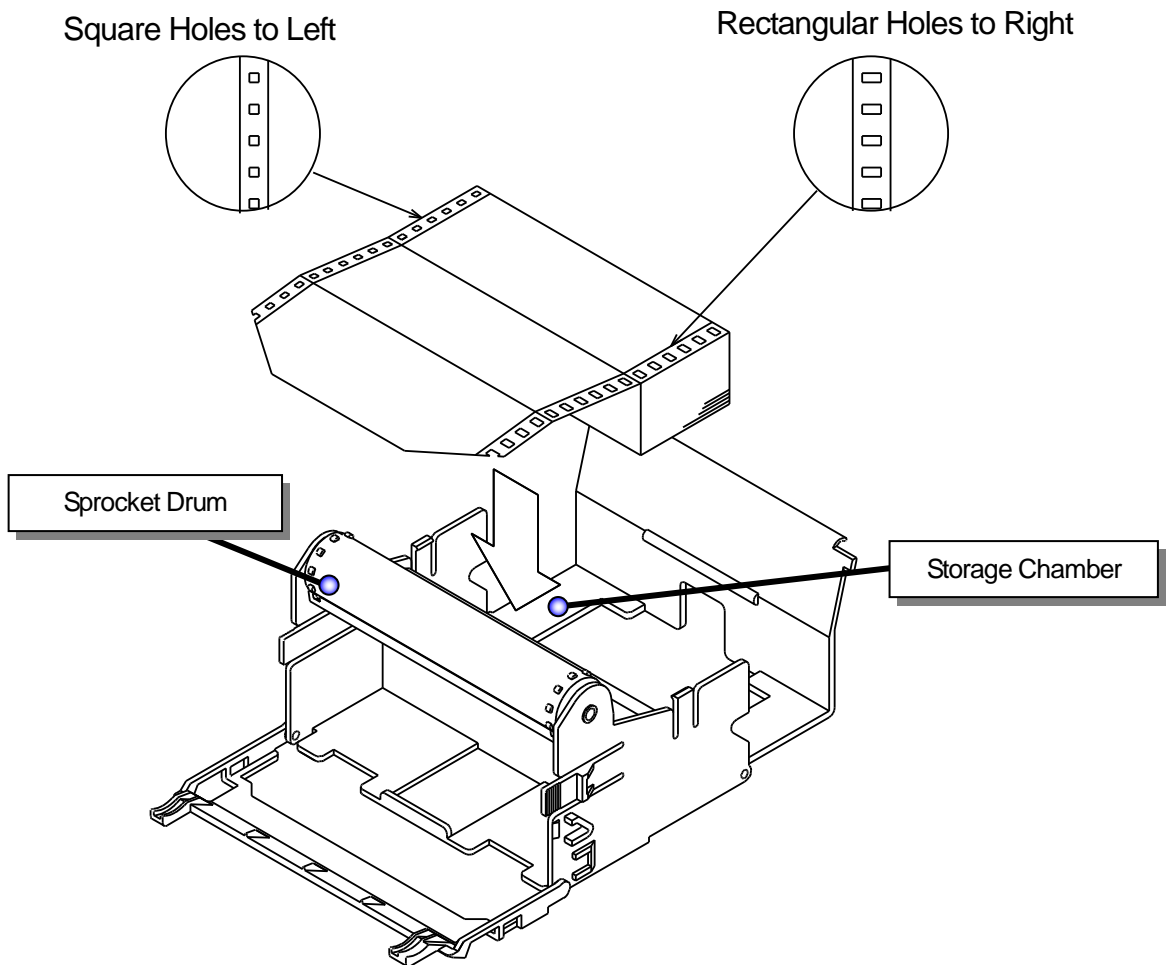

**Fig. 5.6 Setting the Chart Paper**

(7) Aligning the Chart Paper with the Sprocket Drum

Align the holes in the chart paper with the sprocket drum teeth. Set the chart paper along the sprocket drum. Put the first ply of the chart paper into the chart receiver.

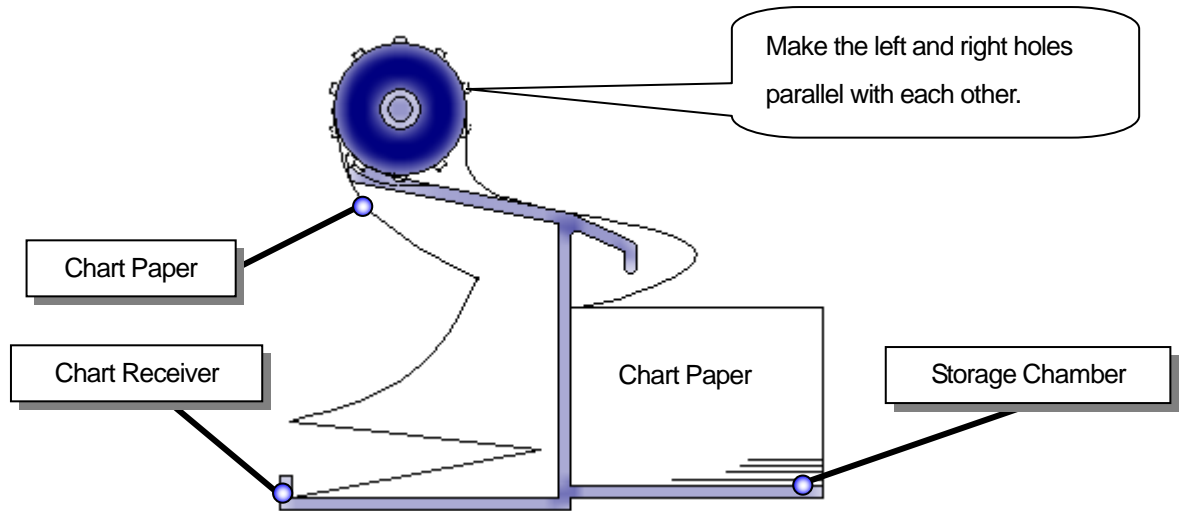

**Fig. 5.7 Aligning the Chart Paper with Sprocket Drum (Chart Holder Sectional View)**

(8) Closing the Chart Cover and Chart Guide

Close the chart cover and the chart guide in the arrow directions.

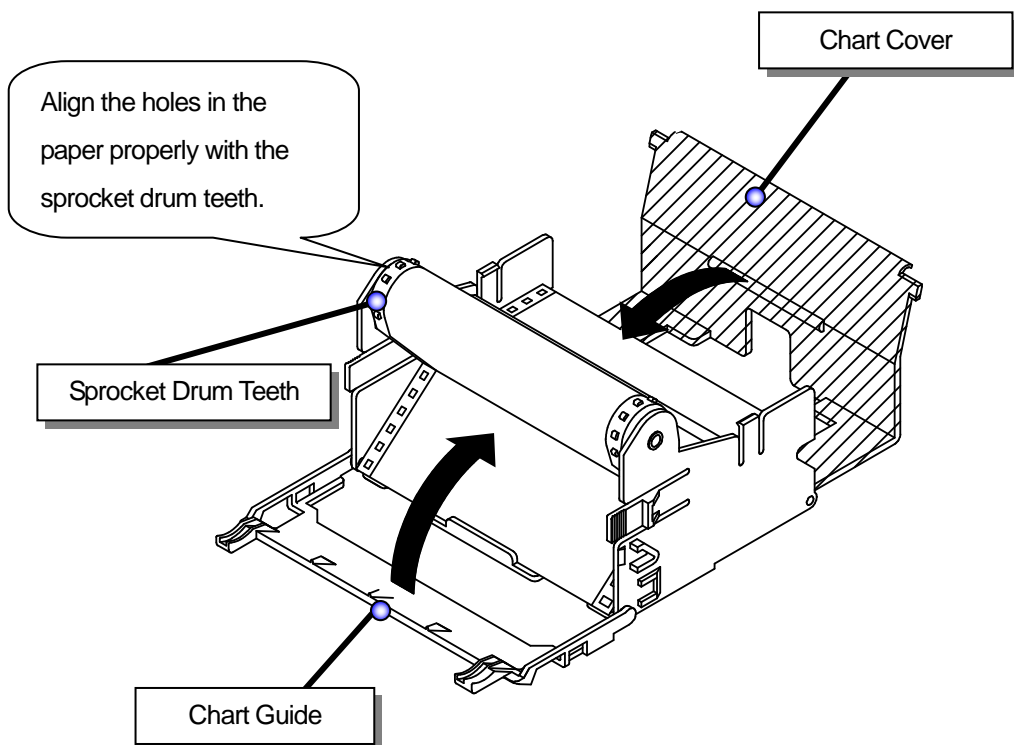
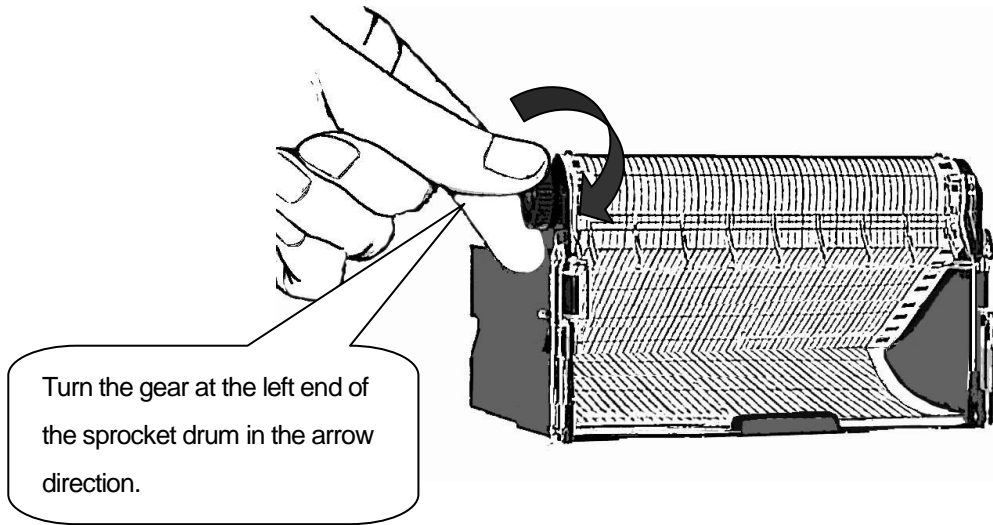

**Fig. 5.8 Closing the Chart Cover and Chart Guide**

(9) Turning the Sprocket Drum Gear

Check paper feed with your hand. Turn the sprocket drum gear to feed out the chart paper.

(It is recommended to feed the chart paper by 4 plies.)



**Fig. 5.9** Checking Paper Feed

(10) Putting Back the Chart Paper Holder

Push in the chart holder horizontally into the case until it is locked.

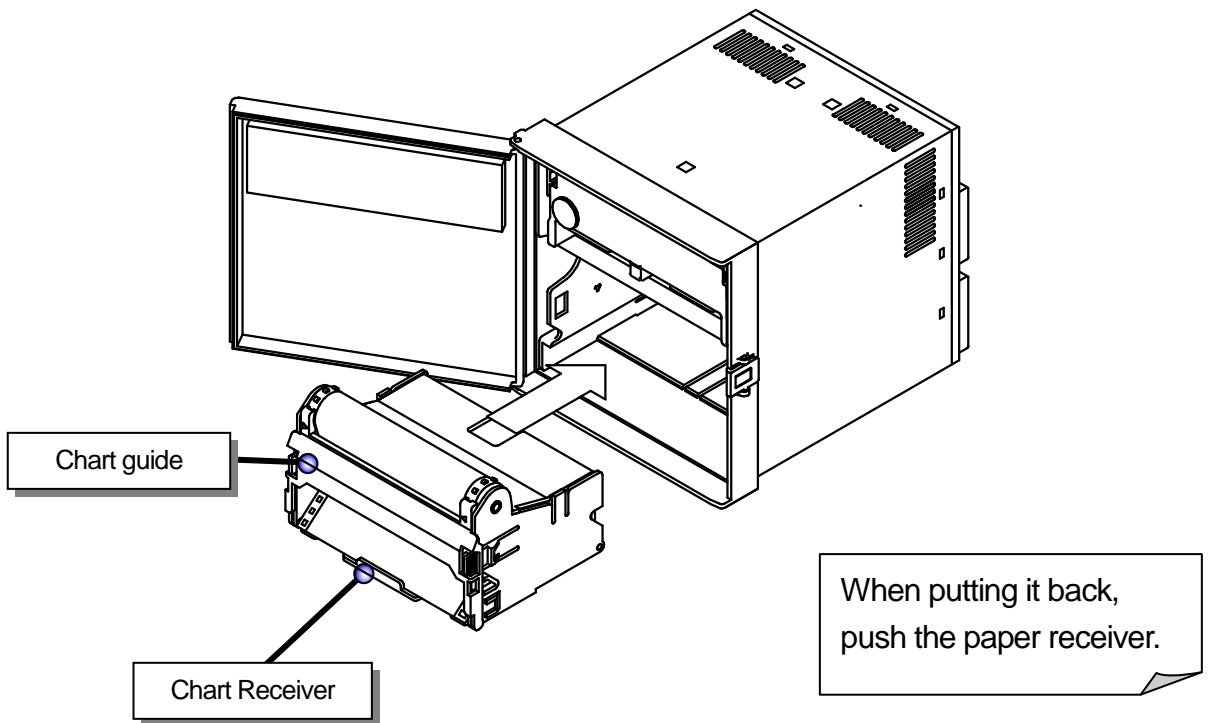

**Fig. 5.10** Putting Back the Chart Holder

(11) Close the Door

Close the door and check a door lock.

(12) Pressing the “FEED” key to Check Paper Feed

Press the “FEED” key on the display keyboard to feed the chart paper.

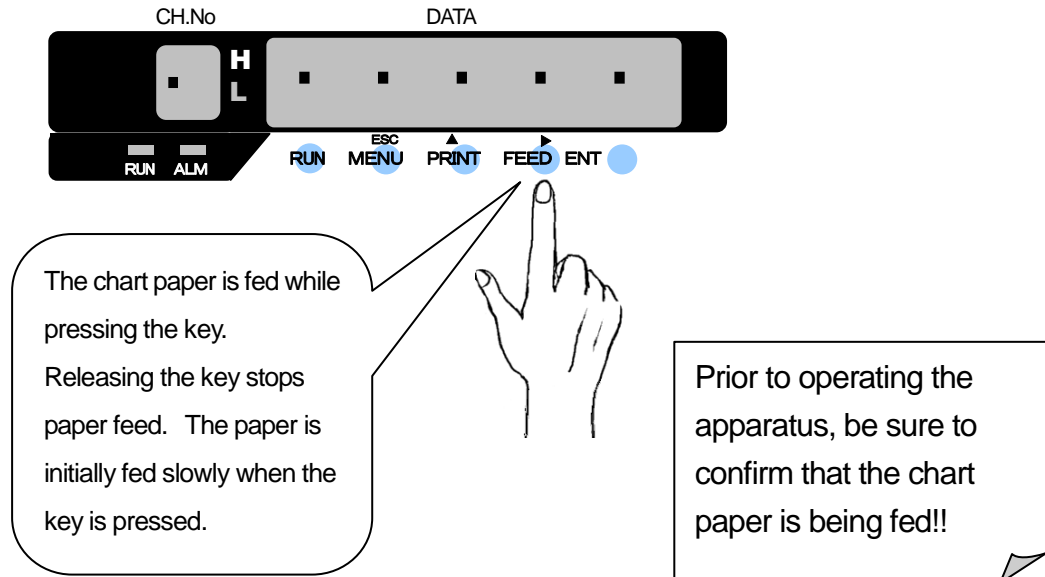

**Fig. 5.11 Pressing the “FEED” key**

(13) Pressing the “RUN” Key to Restart Operation

## 5.2 Setting the Ribbon Cassette



### CAUTION

If the chart holder is taken out with recording operation being activated, the ink ribbon may be damaged. To replace the ribbon cassette, be sure to press the “RUN” key to stop recording. If the ribbon cassette is not set properly, the recording color may change or the ribbon may be damaged.

#### (1) Pressing the “RUN” key for 3 seconds or more

Stop recording. With the power turned on, press the “RUN” key for 3 seconds or more.

Once recording stops, the RUN lamp goes off. (See Fig. 5.1 on page 23)

#### (2) Opening the Door

Push the door hook to unlock the door. Pull the door to this side to open it. (See Fig.5.2 on page 23)



### WARNING

Because you may be hurt when you put fingers at the time of the opening and closing of the door, please be careful.



### CAUTION

Maximum angle of the door in opened-state is 135 degree. Do not further open the door otherwise hinge will be broken.

#### (3) Taking out the Ribbon Cassette

Grab the left side of the ribbon cassette. Holding down the ribbon holder, take out the ribbon cassette to the front.

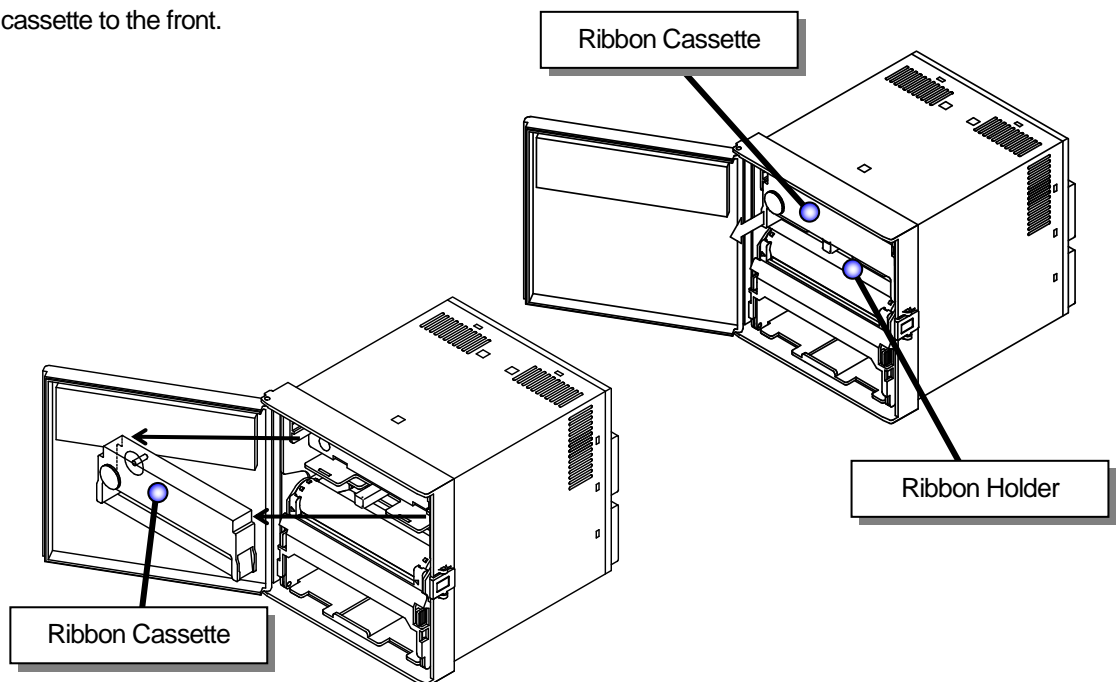
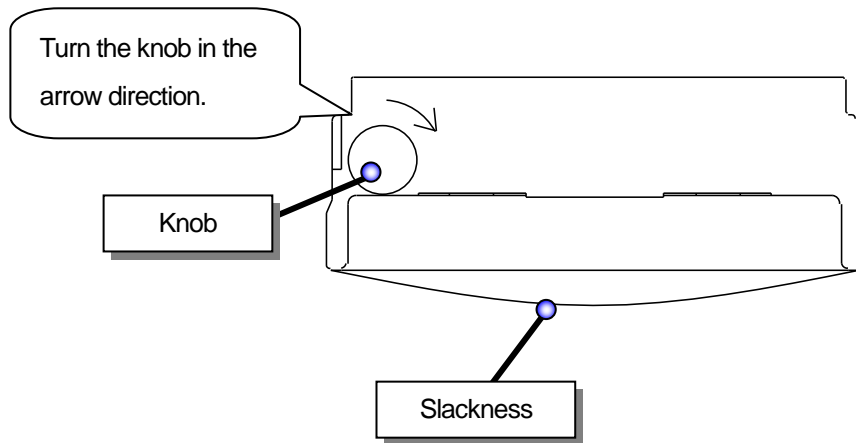

Fig. 5.12 Taking Out the Ribbon Cassette

#### (4) Unslacking the Ink Ribbon

Set the new ink ribbon. Turn the knob in the arrow direction to unslack the ink ribbon.

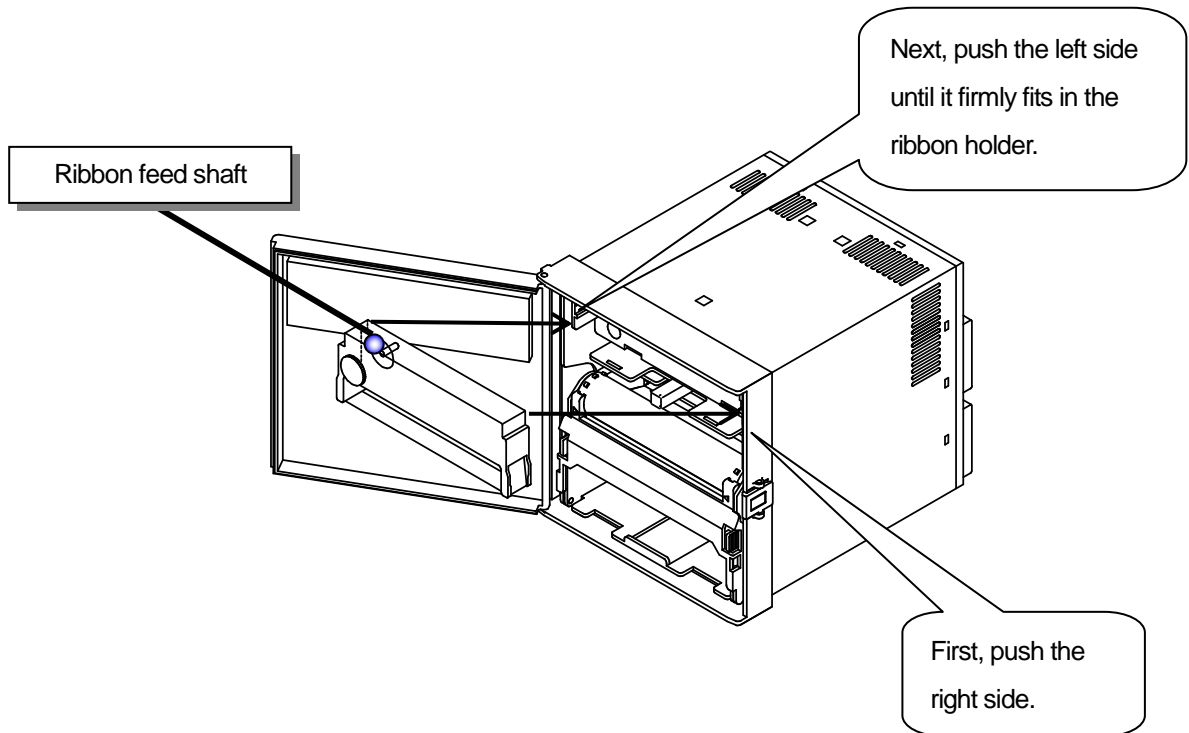

**Fig. 5.13 Unslacking the Ink Ribbon**

#### (5) Setting the Ribbon Cassette

Push the ribbon cassette into the ribbon holder until the latch clicks.

When the ribbon feed shaft is not easily fit in, turn the gear to the direction of an arrow to adjust the position. When this is done, push the ribbon cassette until the latch clicks



**Fig. 5.14 Setting the Ribbon Cassette**

# 6. OPERATION

## 6.1 Operation

### **WARNING**

Prior to turning on the power, make sure that the supply voltage meets the specifications for the instrument and the instrument is properly grounded.

### **CAUTION**

Prior to turning on the power, make sure that the chart paper is set in the chart holder.  
If the printer is activated with no chart paper set, the sprocket drum (cylindrical part) of the chart holder may

Once the power is turned on, the display on the front of the door is illuminated. The instrument will be ready to run (user mode) in about 5 seconds, including the initial screen. If the RUN lamp is unilluminated, press the "RUN" key to start recording operation.

#### 6.1.1 Status after Initial Screen

- (1) Display screen :The "RUN" lamp keeps the condition of before power-off.
- (2) Printout data :All printing data and analog recording data of before power-off are cleared.
- (3) Alarm and Diagnosis :Alarm indications and outputs of before power-off are not recovered.
- (4) Data display and Channel number are displayd refer to Fig.6.1.

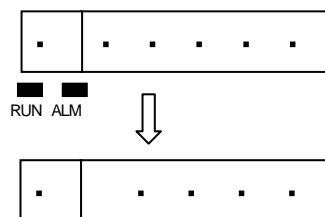

※Returning to the mode before the power OFF.

Fig. 6.1 Display Screen at Power-on

#### [Note]

- ① When electric power failure occurs, the initialization is performed after power recovery. And it becomes the above initial state.
- ② The printout data are eliminated in initialization. Printout operation is not continued after power recovery when the power is turned off during printout.
- ③ When the power is turned on, the display displays "0" while reading data in fig.6.1. The numeral of the display digit depends on the setting.



## 6.2 Recording



### CAUTION

- ① The instrument checks zero point for every recording. If the printer block is manually moved during recording, a recording position may be dislocated.
- ② In order to protect the chart paper, dot printing is not performed when the distance between the previous dot printing position and the next one for an identical channel is less than 0.4 mm in the chart paper feed direction or less than 0.5 mm in the scale direction.

### 6.2.1 Recording Colors

Table 6.1 lists the recording colors for each channel in analog recording.

You can select a recording color from 6 colors for every channel.

**Table 6.1 Recording Colors(standard)**

Channel No.	Color
1	Purple
2	Red
3	Green
4	Blue
5	Brown
6	Black

## 6.3 How to Record

### 6.3.1 Starting/Stopping Recording Operation

To start/stop recording, press the “RUN” key.

To stop, hold down the “RUN” key for 3 seconds or more.

“RUN” lamp is unilluminated when step recording.

“RUN” lamp is unilluminated when stop recording.

#### [Note]

- ① When the power is turned on, the previous state where you turned off is continued.
- ② When controlling a start/stop of recording through Digital Input (DI, option), you cannot switch start/stop with the “RUN” key.

### 6.3.2 Feed the Chart Paper

The chart paper is fed while the “FEED” key is pressed, and stops when released.

### 6.3.3 Print Sample

#### Logging on print example and Alarm on print example

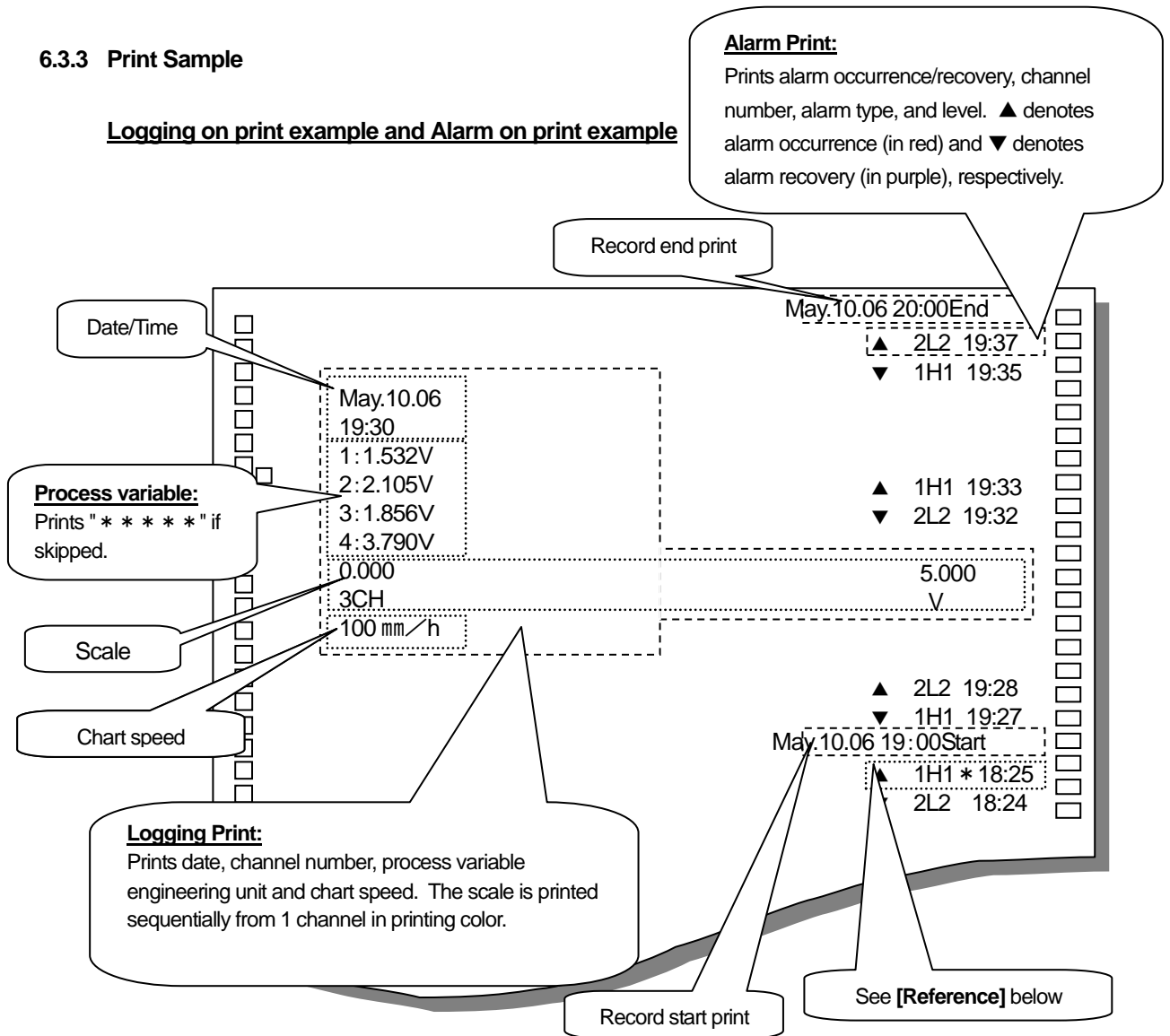

Fig. 6.2 Print Sample

#### **[Reference]**

Alarm print, Comment print, Date-and-Time print and Record Start/End print becomes waited-state if the other printing is actuated.

CR06 stores up to six items of Alarm Occurrence/Recovery print and five items of Comment/Date-and-Time/Record Start/Record end print. If printing commands are over, CR06 prints a marking " \* " on the end of the last printing. This mark is meaning of that over items would not be printed.

For priority of respective printing, see next page; Priority in Reference.

#### **[Note]**

Logging print will not be the wait printing state. At the start time of Logging print, if the prior Logging print is printing, the next one cannot print. Prolong the printing interval of Logging print in this case.

## 6.4 Digital Print

The following digital prints operate by the key operation:

- Manual
- List print
- print
- 
- Record
- Engineering list print
- Start/End print
- 

The following digital prints operate by the DI input:

- DI Manual
- DI
- print
- Date/Time print
- 
- DI
- Comment print

### [Reference]

Printing is actuated in following priority. See following Priority Order. When multiple types of printing are activated simultaneously, higher-priority printing takes effect first according as following order. In alarm printing activation, lower category (Logging, DI Manual) also is activated. (See Fig. 6.2 that is example : Same time printing of Alarm and Logging print).

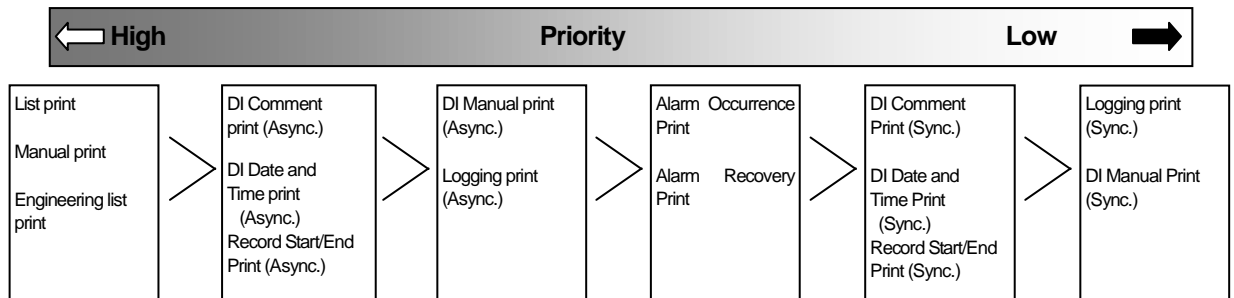

The Synchronous printout synchronizes with the analog record and does a digital printout. In case of the asynchronous printout, it stops an analog record and it executes a digital printout. It resumes an analog record after the digital printout completes.

### 6.4.1 Manual Print

Print the following data on the chart paper:

- Time/date (year, month, day)
- Channel number or activated alarm type, latest process variable, engineering unit (all channels)

(1) Manual print operating procedure

- ① Press the "PRINT" key.
- ② Use the "PRINT" key to display "· · ·", and press the "ENT" key.
- ③ Use the "PRINT" key to select "· · · · ·". Pressing the "ENT" key executes manual print.

Once manual print starts, the display is automatically returned to the Data Display screen.

Upon termination of manual print, it is returned to it was prior to starting manual print.

### [Note]

- ① Analog recording is interrupted while manual print is running. However, measurement/alarm detection remains effective.
- ② If an alarm is activated while manual print is running, alarm print will be performed when recording restarts.

(2) Manual print stopping procedure

- ① Press the “PRINT” key.
- ② Use the “PRINT” key to display “· · · · ”, and press the “ENT” key.
- ③ Use the “PRINT” key to select “· · · · ”. Pressing the “ENT” key stops manual print.

However, print operation continues until the line is completed. Manual print is stopped.

And the display returned it was prior to starting manual print.

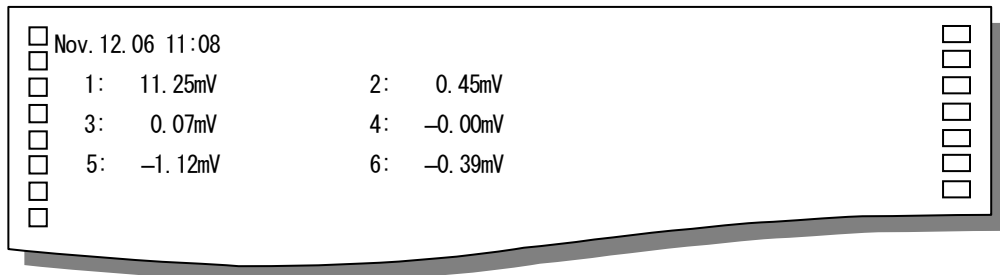

Fig. 6.3 Manual Print

#### 6.4.2 List Print

Print the following setting data of the instrument on the paper:

- Date/time/Chart speed/2nd chart speed/Printing cycle.
- Channel number/range/scaling value/engineering unit
- Setting alarm type

(1) List print operating procedure

- ① Press the “PRINT” key.
- ② Use the “PRINT” key to display “· · · · ”, and press the “ENT” key.
- ③ Use the “PRINT” key to select “· · · · ”. Pressing the “ENT” key executes list print.

Once list print starts, the display is automatically returned to the Data Display screen.

Upon termination of list print, it is returned to it was prior to starting list print.

**[Note]**

- ① Analog recording is interrupted while list print is running. However, measurement/alarm detection remains effective.
- ② If an alarm is activated while list print is running, alarm print will be performed when recording restarts.

(2) List print stopping procedure

- ① Press the "PRINT" key.
- ② Use the "PRINT" key to display ". . . .", and press the "ENT" key.
- ③ Use the "PRINT" key to select ". . . .". Pressing the "ENT" key stops list print.

However, print operation continues until the line is completed. List print is stopped.

And the display returned to it was prior to starting list print.

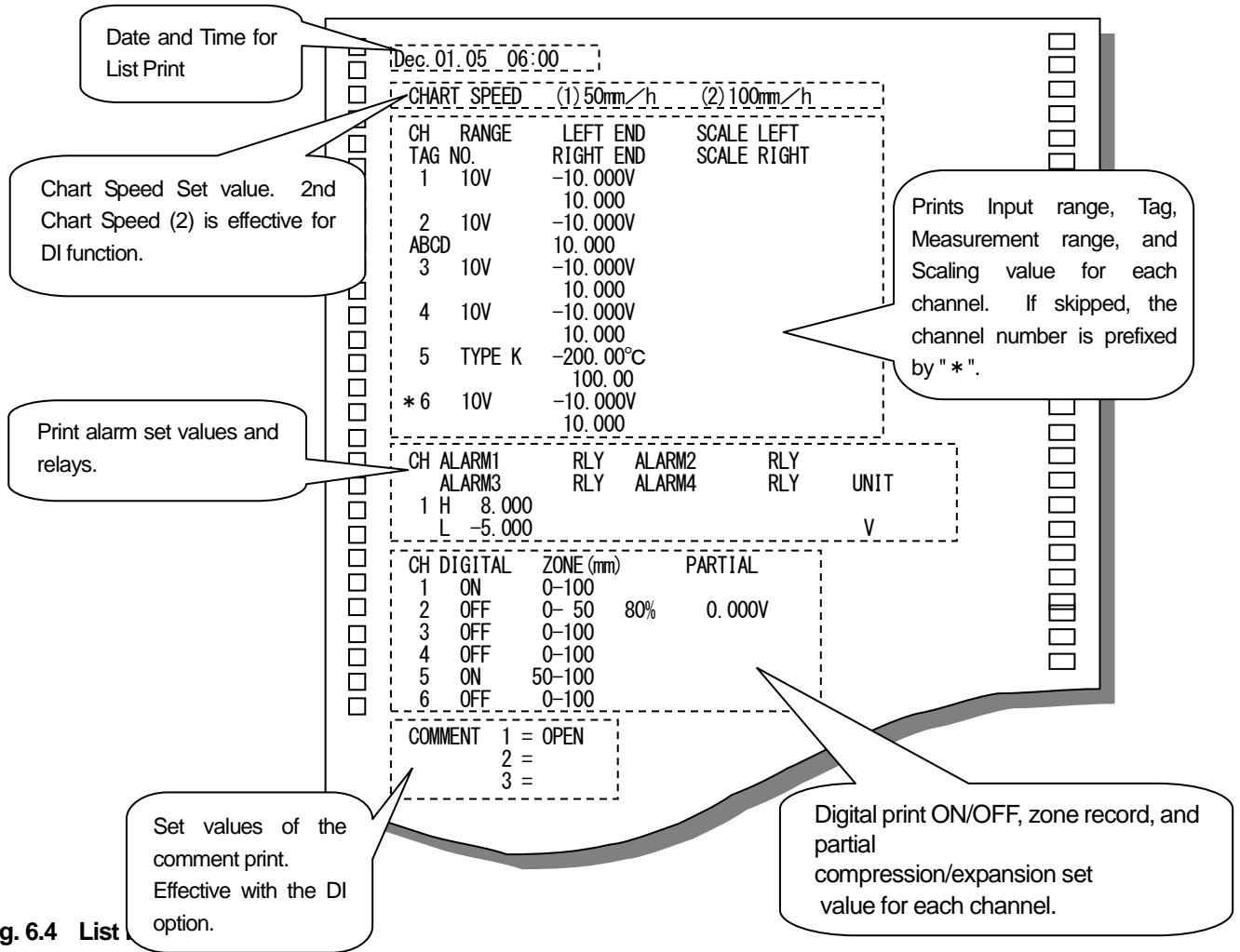

Fig. 6.4 List

### 6.4.3 Engineering List Print

Engineering list print provides the following setting data of the instrument on the chart paper.

- Analog recording
- Digital printing
- Burnout/RJC etc.

(1) Engineering list print operating procedure

- ① Press the “MENU” key.
- ② Use the “PRINT” key to display “· · · · ·”, and press the “ENT” key.
- ③ Use the “PRINT” key to select “· · · · ·”. Pressing the “ENT” key executes engineering list print.

Once engineering list print starts, the display is automatically returned to the Data Display screen.

Upon termination of engineering list print, it is returned to it was prior to starting engineering list print.

#### **[Note]**

- ① Analog recording is interrupted while engineering list print is running.  
However, measurement/alarm detection remains effective.
- ② If an alarm is activated while engineering list print is running, alarm print will be performed when recording restarts.

(2) Engineering list print stopping procedure

- ① Press the "MENU" key.
- ② Use the "PRINT" key to display ". . . . .", and press the "ENT" key.
- ③ Use the "PRINT" key to select ". . . . .". Pressing the "ENT" key stops engineering list print.

However, print operation continues until the line is completed.

Engineering list print stopped. And the display returned to it was prior to starting engineering list print.

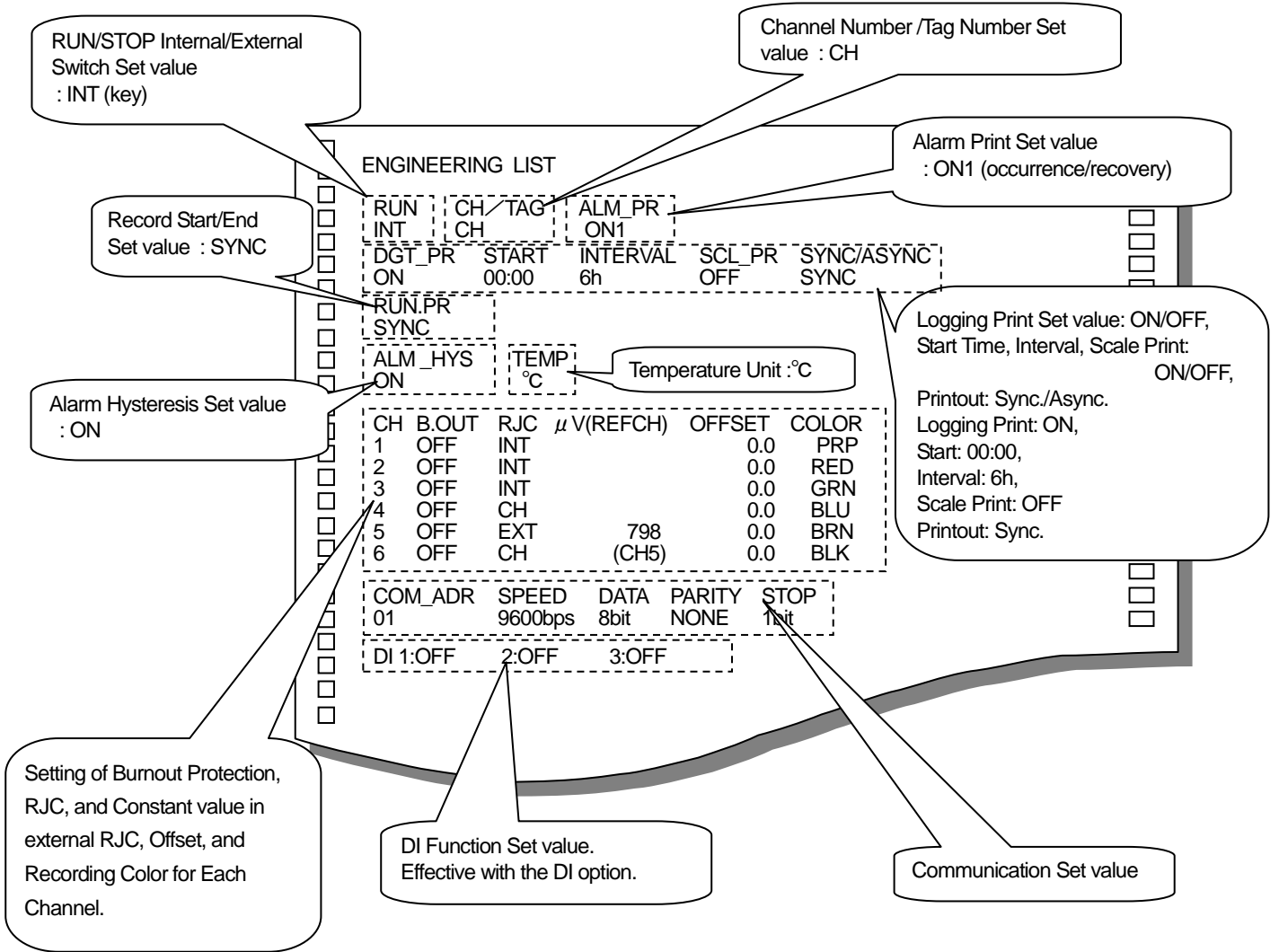

Fig. 6.5 Engineering List Print

#### 6.4.4 Record Start/End Print

Record Start/End print the beginning (or ending) time on the chart paper when beginning (or ending) to record. Record Start/End operation is set in the engineering mode. (Refer to 7.2.6 "Record Start/End print" )

" . . . . " ..... Record start print is synchronous print.

Record end print is asynchronous print.

" . . . . " ..... Record Start/End print is asynchronous print.

" . . . " ..... Record Start/End print is not done.

##### (1) Record start print

When the record begins, the recorder prints the start time.

##### (2) Record end print

When the record is ended, the recorder prints the end time.

#### **[Note]**

When the record operation is not a key but DI, the print is done by the operation by DI.

#### 6.4.5 DI Manual Print (option)

DI manual print prints measurements and time on paper by turning on DI.

The content of the print is the same as 6.4.1 "Manual Print".

##### (1) "DI function" of the engineering mode is set.

Please refer to 7.2.9 "DI Functions" for details.

" . . . . " ..... Manual print is synchronous print.

" . . . . " ..... Manual print is asynchronous print.

##### (2) DI is operated.

DI manual print is printed by turning on DI.

#### 6.4.6 DI Date/Time Print (option)

DI Date/Time print prints date and time on paper by turning on DI.

##### (1) "DI function" of the engineering mode is set.

Please refer to 7.2.9 "DI Functions" for details.

" . . . . " ..... Date/Time print is synchronous print.

" . . . . " ..... Date/Time print is asynchronous print.

##### (2) DI is operated.

DI manual print is printed by turning on DI.



### 6.4.7 DI Comment Print (option)

DI Comment print prints time and comment on paper by turning on DI.

The content of comment is set to the setup mode.

(1)"DI function" of the engineering mode is set.

Please refer to 7.2.9 "DI Functions" for details.

" . . . . . "; " . . . . . "; " . . . . . " ..... Date/Time print is synchronous print.

" . . . . . "; " . . . . . "; " . . . . . " ..... Date/Time print is asynchronous print.

(2)DI is operated.

DI manual print is printed by turning on DI.

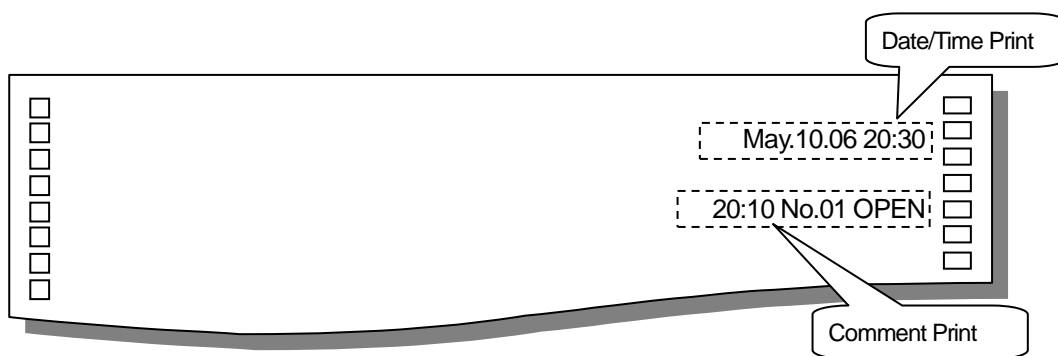

Fig. 6.6 Date/Time print, Comment print

## 6.5 Changing the Display

### Display selection procedure

- ① Press the "MENU" key to display ". . . .", and press the "ENT" key.
- ② Use the "PRINT" key to select a required display screen from the menu below.  
Press the "ENT" key.
- ③ ". . □" is displayed in case of manual display. Use the "PRINT" key to select the channel number.

Press the "ENT" key.

- ". . . ."(AUTO) : Auto display
- ". . . ."(MAN) : Manual display
- ". . . ."(DATE) : Date display
- ". . . ."(TIME) : Time display
- ". . . ."(OFF) : Display off

#### 6.5.1 . . . . <Auto Display>

Displays the process variable of each channel sequentially at intervals of 2.5 seconds.

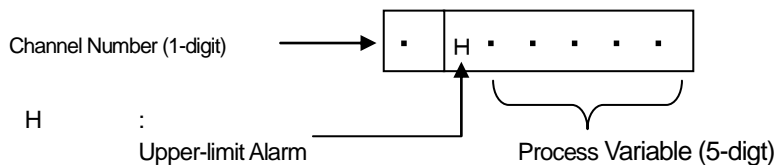

#### 6.5.2 . . . . <Manual Display>

Displays the process variable of specific channel, it updates every measurement cycle.

The data is the same as Auto display. Pressing the "ENT" key changes the displayed channel number (it increments).

#### 6.5.3 . . . . <Date Display>

Displays the month and day. Leap year adjustment is automatic.

Example of October 18

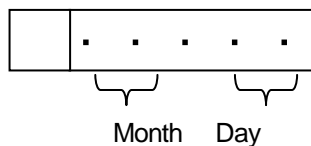

#### 6.5.4 . . . . <Time Display>

Displays hour and minute.

Example of 12:15

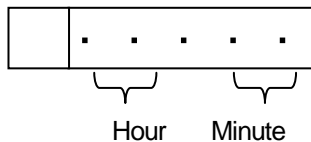

#### 6.5.5 . . . . <Display Off>

Turns off the process variable display. Key operation is the same as usual. To switch to other display, take steps ① through ③ mentioned above.

# 7. DEVICE SETTING

## 7.1 Setting the Setup Mode

### Key Operation for Entering the Setup Mode

Press the "MENU" key for 3 seconds or more to enter the setup mode.

At the time, displays the version of the software approximately 1 seconds as below. After, displays the setting screen of the range.

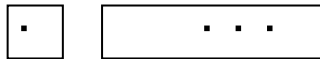

To return from the setup mode to the recording mode (user mode), press the "MENU" key for 3 seconds or more again.

The following describes how to set the following items.

The following shows a display map of the setup mode. Use the Δ key to operate.

### ● 7.1.1 Setting the Range

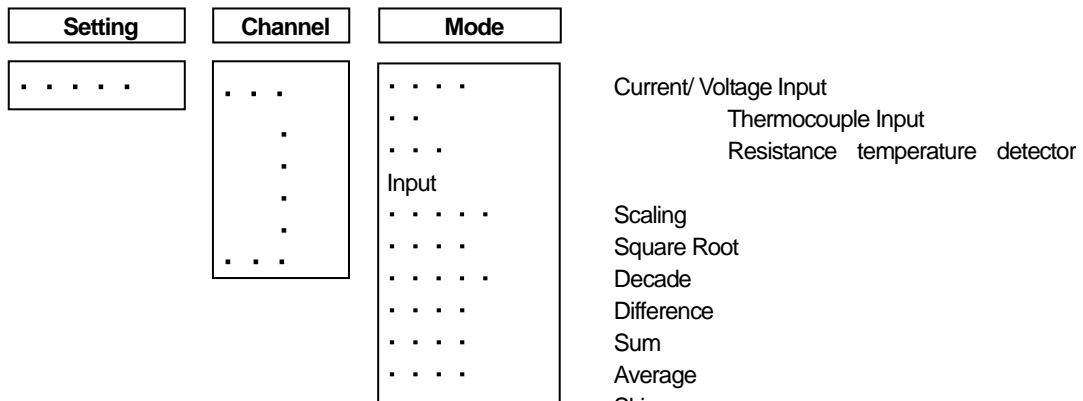

### ● 7.1.2 Setting the Alarm

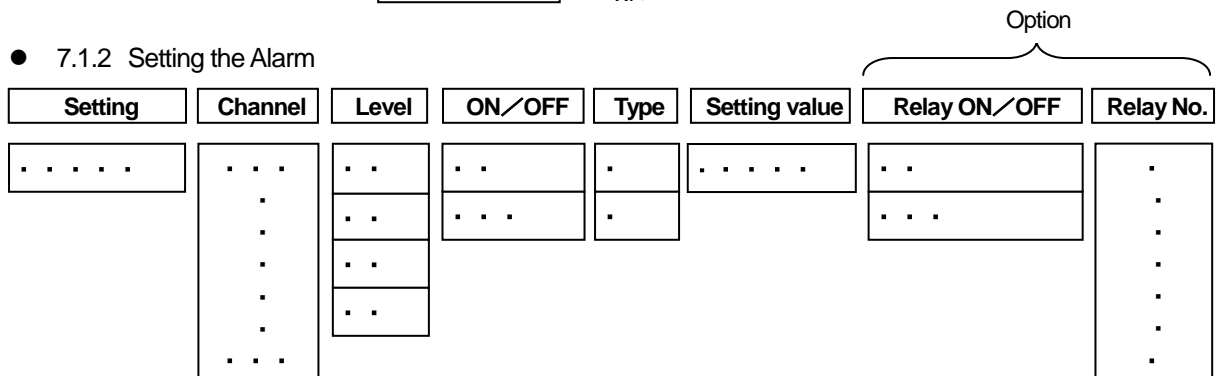

- 7.1.3 Setting the Unit

Setting	Channel	Char. No.	Code No.	
.....	.....	.	.. ..	(°)
	.	.	.. ..	(. )
	.	.	.. ..	End
	.	.		
	.	.		
	.	.		

- 7.1.4 Setting the Chart Speed

Setting	1st/2nd Chart speed	Chart speed
.....	.....	.....
	.....	

- 7.1.5 Setting the Date and Time

Setting	Year	Month, Day	Time
.....	.....	.....	.....

- 7.1.6 Copying the Setting Data

Setting	Copy-from Channel	Copy-to Channel
.....	.....	.....
	.....	.....
	.	.
	.	.
	.....	.....

- 7.1.7 Setting Other Functions (Printing Cycle, Zone Recording, Partial Compression/Expansion, Digital Print, Tag, Comment Words)

Setting	Mode	
...	.....	Printing Cycle
	.....	Zone Recording
	.....	Partial Compression/Expansion
	.....	Digital Print
	.....	Tag
	.....	Comment Words

- Shift to the engineering mode

Setting	Password	
...	.....	Input the password to go to the engineering mode.

Table 7.1 Initial setting value of the Setup mode operation in page 69.

Setting items	Initial set	Remarks
★Range (all channels)	±10mV Scaling 0~100.0 (°C)	
★Alarm (all channels)	All levels are alarm OFF, relay OFF	
★Engineering unit (all channels)	°C(BF 43 00)	
★Chart speed	(1) 20mm/h (2) 20mm/h	
★Time	2000/01/01, 00:00	Sets up the present time. (Japan standard time) GMT+09:00
★Dot point interval	10 (s)	
★Zone setting (all channels)	0~100 (%)	
★Partial compression/expansion (all channels)	OFF	
★ Digital print (all channels)	ON	
★Tag print character (all channels)	"Blank until the 7th character"	
★Comment print word (1~3)	"Blank until the 16th character"	

### 7.1.1 Setting the Range

#### (1) Setting method

With a multirange system, setting the range for each channel is possible.

Use the  $\Delta$  key to shift the mode ① to ⑩ shown in the Table below.

Set the range from the following input signals. (mode ① to ③)

DC voltage	: $\pm 10, 0$ to $20, 0$ to $50, \pm 200$ mV DC, $\pm 1, 0$ to $5, \pm 10$ V DC
DC current	: 4 to 20 mA DC (External shunt resistor: 250 $\Omega$ )
Thermocouple	: B, R, S, K, E, J, T, C, Au-Fe, N, PR40-20, PL II, U, L
Resistance temperature detector	: Pt100, JPt100

Set scaling, decade, square root, interchannel sum/difference/average. (mode ④ to ⑨)

Unnecessary channels can be skipped. (mode ⑩)

Setting	Channel	Mode	Key
. . . . .	. . . .	① . . . . (Voltage, Current)	$\Delta$ key
		② . . (Thermocouple)	↓
		③ . . . . (Resistance temperature detector)	↓
		④ . . . . . (Scaling)	↓
		⑤ . . . . . (Square root)	↓
		⑥ . . . . . (Decade)	↓
		⑦ . . . . . (Difference)	↓
		⑧ . . . . . (Sum)	↓
		⑨ . . . . . (Average)	↓
		Setting for all channels	⑩ . . . . . (Skip)

#### [Note]















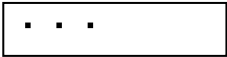



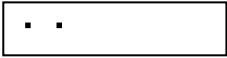



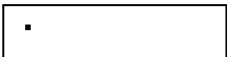

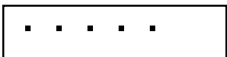

A decimal point position can be arbitrary setup only in the "scaling" and "square root" modes. When you want to alter the decimal point position in Voltage/Current/Thermocouple/Resistance temperature detector input set it in the "scaling" mode. To fix the decimal point position, set as follows.

Input	Decimal Places	Input	Decimal Places
mV	2nd place * * * . * *	Thermocouple	1st place * * * * . *
$\pm 1, 0 \sim 5V$	3rd place * * . * * *	RTD	1st place * * * * . *
$\pm 10V$	2nd place * * * . * *	$\pm 200mV$ DC	1st place * * * * . *
mA	2nd place * * * . * *		

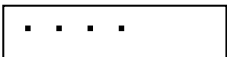

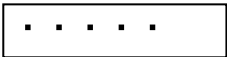

**(2) . . . . (Current/Voltage), . . (Thermocouple), . . . (Resistance Temperature Detector)**

Measures Current, Voltage, Thermocouple and RTD.

Example) When setting Thermocouple T for Channel 1(T :-100 to 300 °C)

Display	Operation keys	Description
 	 3sec 	Hold down the “MENU” key for 3 seconds or more to enter the setup mode. Displays ". . . . .", then, press the “ENT” key.
 	 	Use the $\Delta$ key to select the channel you want to set. Press the “ENT” key.
 	 	Use the $\Delta$ key to select the mode. Press the “ENT” key.
 	 	Use the $\Delta$ key to select the type. Press the “ENT” key.
  (Zero setting)	  	Use the $\Delta$ key to select a sign and numeral. Use the . key to shift a digit. Press the “ENT” key.
  (Span setting)	  	Use the $\Delta$ key to select a sign and numeral. Use the . key to shift a digit. Press the “ENT” key.
 		Press the “ENT” key. Setting is completed. To return to the user mode, hold down the “MENU” key for 3 seconds or more.

**[Note]**

- ① An entry of an incorrect numeral displays an error,   or   .  
Press the “ENT” key and re-enter a correct numeral.
- ② For the range setting (When especially, don't change a decimal point position at the thermocouple or in RTD) which doesn't have the necessity of the scaling, don't set a scaling.

**[Note]**

In the . . . . , . . . , or . . . mode, press the “ENT” key to select the range.

Use the  $\Delta$  key, you can select the type out of the range.

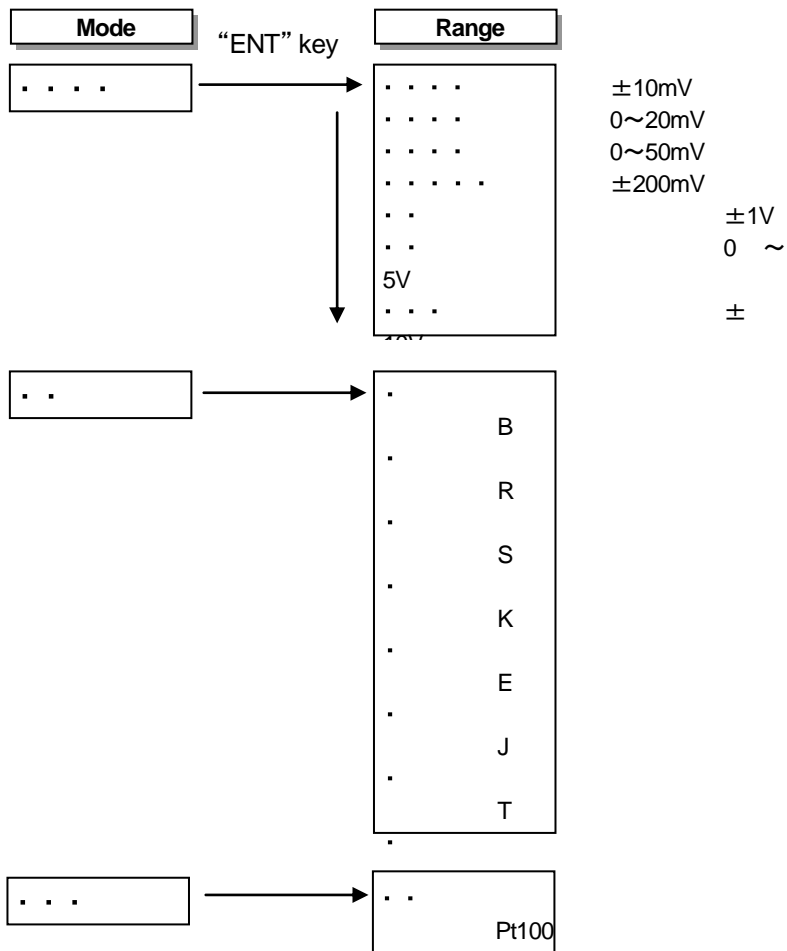









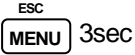

**(3) . . . . . (Scaling)**

Changes the input of VOLT, TC and RTD into a quantity.

Setting the unit is possible. (See 7.1.3 on page 58)

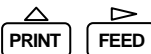

Example) When setting the voltage of 0 to 40 mV and scale of 000.00 to 100.00 for Channel 1.

Display	Operation keys	Description
<input type="checkbox"/> . . . . .	 	Hold down the "MENU" key for 3 seconds or more to enter the setup mode. Use the $\Delta$ key to display ". . . . .". Press the "ENT" key.
<input type="checkbox"/> . . .		Use the $\Delta$ key to select the channel you want to set. Press the "ENT" key.
<input type="checkbox"/> . . . . .		Use the $\Delta$ key to select ". . . . .". Press the "ENT" key.
<input type="checkbox"/> . . . . .		Use the $\Delta$ key to select ". . . . .". Press the "ENT" key.
<input type="checkbox"/> . . . . .		Use the $\Delta$ key to select a range(50 mV). Press the "ENT" key.
<input type="checkbox"/> . <input type="checkbox"/> . . . . . (Zero input value)	 	Use the $\Delta$ key to select a numeral. Use the . key to shift a digit. Press the "ENT" key.

**[Note]**  
When input TC and RTD, set the Zero input value equal to the Zero-side scale value.  
But, set a decimal point position to the standard position. (\* 1:next page)

<input type="checkbox"/> . <input type="checkbox"/> . . . . . (Span input value)	 	Use the $\Delta$ key to select a numeral. Use the . key to shift a digit. Press the "ENT" key.
---	--	---



**[Note]**  
When input TC and RTD, set the Span input value equal to the Span-side scale value.  
But, set a decimal point position to the standard position. (\* 2:next page)

(Zero-side scale value) (\* 1)

Use the  $\Delta$  key to select a numeral.



Use the  $\cdot$  key to shift a digit.

(Decimal point)



Press the  $\cdot$  key again in the lowest digit(right end) to blink a decimal point. Use the  $\Delta$  key to select a decimal point position. Press the “ENT” key.







(Span-side scale value) (\* 2)

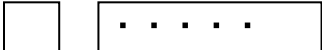

Use the  $\Delta$  key to select a numeral.





Use the  $\cdot$  key to shift a digit. Press the “ENT” key.

Press the “ENT” key. Setting is completed.

To return to the user mode, hold down the “MENU” key for 3 seconds or more.

### [Note]

An entry of an incorrect numeral displays errors   or  or  .  
Press the “ENT” key and re-enter a correct numeral.

**(4) . . . . (Square Root)**

Calculates the square root of Volt input, and scaling that value.

Setting the unit is possible. (See 7.1.3 on page 58)

Example) When setting the voltage of 0 to 40 mV and scale of 000.00 to 100.00 for Channel 1.

Display	Operation keys	Description
<div style="display: flex; align-items: center;"> <div style="border: 1px solid black; width: 30px; height: 30px; margin-right: 10px;"></div> <div style="border: 1px solid black; padding: 5px; display: flex; justify-content: space-around; width: 150px;"> <span>. . . . .</span> </div> </div>	<div style="text-align: center;"> <small>ESC</small>  <div style="border: 1px solid black; padding: 2px; display: inline-block; margin-bottom: 5px;">MENU</div> 3sec  <div style="display: flex; justify-content: space-around; margin-top: 5px;"> <div style="border: 1px solid black; padding: 2px; text-align: center;">△</div> <div style="border: 1px solid black; padding: 2px; text-align: center;">ENT</div> </div> <div style="display: flex; justify-content: space-around; margin-top: 5px;"> <div style="border: 1px solid black; padding: 2px; text-align: center;">PRINT</div> <div style="border: 1px solid black; padding: 2px; text-align: center;">ENT</div> </div> </div>	<p>Hold down the “MENU” key for 3 seconds or more to enter the setup mode. Use the △ key to display ". . . . .". Press the “ENT” key.</p>
<div style="display: flex; align-items: center;"> <div style="border: 1px solid black; width: 30px; height: 30px; margin-right: 10px;"></div> <div style="border: 1px solid black; padding: 5px; display: flex; justify-content: space-around; width: 150px;"> <span>. . .</span> </div> </div>	<div style="text-align: center;"> <div style="border: 1px solid black; padding: 2px; text-align: center;">△</div> <div style="display: flex; justify-content: space-around; margin-top: 5px;"> <div style="border: 1px solid black; padding: 2px; text-align: center;">PRINT</div> <div style="border: 1px solid black; padding: 2px; text-align: center;">ENT</div> </div> </div>	<p>Use the △ key to select the channel you want to set. Press the “ENT” key.</p>
<div style="display: flex; align-items: center;"> <div style="border: 1px solid black; width: 30px; height: 30px; margin-right: 10px;"></div> <div style="border: 1px solid black; padding: 5px; display: flex; justify-content: space-around; width: 150px;"> <span>. . . .</span> </div> </div>	<div style="text-align: center;"> <div style="border: 1px solid black; padding: 2px; text-align: center;">△</div> <div style="display: flex; justify-content: space-around; margin-top: 5px;"> <div style="border: 1px solid black; padding: 2px; text-align: center;">PRINT</div> <div style="border: 1px solid black; padding: 2px; text-align: center;">ENT</div> </div> </div>	<p>Use the △ key to select ". . . .". Press the “ENT” key.</p>
<div style="display: flex; align-items: center;"> <div style="border: 1px solid black; width: 30px; height: 30px; margin-right: 10px;"></div> <div style="border: 1px solid black; padding: 5px; display: flex; justify-content: space-around; width: 150px;"> <span>. . . .</span> </div> </div>	<div style="text-align: center;"> <div style="border: 1px solid black; padding: 2px; text-align: center;">△</div> <div style="display: flex; justify-content: space-around; margin-top: 5px;"> <div style="border: 1px solid black; padding: 2px; text-align: center;">PRINT</div> <div style="border: 1px solid black; padding: 2px; text-align: center;">ENT</div> </div> </div>	<p>Use the △ key to select a range(50 mV). Press the “ENT” key.</p>
<div style="display: flex; align-items: center;"> <div style="border: 1px solid black; width: 30px; height: 30px; margin-right: 10px; display: flex; align-items: center; justify-content: center;"> <span>.</span> </div> <div style="border: 1px solid black; padding: 5px; display: flex; justify-content: space-around; width: 150px;"> <span>. . . . .</span> </div> </div> <p style="margin-top: 5px;">(Zero input value)</p>	<div style="text-align: center;"> <div style="display: flex; justify-content: space-around; margin-bottom: 5px;"> <div style="border: 1px solid black; padding: 2px; text-align: center;">△</div> <div style="border: 1px solid black; padding: 2px; text-align: center;">▶</div> </div> <div style="display: flex; justify-content: space-around; margin-bottom: 5px;"> <div style="border: 1px solid black; padding: 2px; text-align: center;">PRINT</div> <div style="border: 1px solid black; padding: 2px; text-align: center;">FEED</div> </div> <div style="border: 1px solid black; padding: 2px; text-align: center; width: 40px; margin: 0 auto;">ENT</div> </div>	<p>Use the △ key to select a numeral. Use the ◦ key to shift a digit. Press the “ENT” key.</p>
<div style="display: flex; align-items: center;"> <div style="border: 1px solid black; width: 30px; height: 30px; margin-right: 10px; display: flex; align-items: center; justify-content: center;"> <span>.</span> </div> <div style="border: 1px solid black; padding: 5px; display: flex; justify-content: space-around; width: 150px;"> <span>. . . . .</span> </div> </div> <p style="margin-top: 5px;">(Span input value)</p>	<div style="text-align: center;"> <div style="display: flex; justify-content: space-around; margin-bottom: 5px;"> <div style="border: 1px solid black; padding: 2px; text-align: center;">△</div> <div style="border: 1px solid black; padding: 2px; text-align: center;">▶</div> </div> <div style="display: flex; justify-content: space-around; margin-bottom: 5px;"> <div style="border: 1px solid black; padding: 2px; text-align: center;">PRINT</div> <div style="border: 1px solid black; padding: 2px; text-align: center;">FEED</div> </div> <div style="border: 1px solid black; padding: 2px; text-align: center; width: 40px; margin: 0 auto;">ENT</div> </div>	<p>Use the △ key to select a numeral. Use the ◦ key to shift a digit. Press the “ENT” key.</p>
<div style="display: flex; align-items: center;"> <div style="border: 1px solid black; width: 30px; height: 30px; margin-right: 10px; display: flex; align-items: center; justify-content: center;"> <span>.</span> </div> <div style="border: 1px solid black; padding: 5px; display: flex; justify-content: space-around; width: 150px;"> <span>. . . . .</span> </div> </div> <p style="margin-top: 5px;">(Zero-side scale value)</p>	<div style="text-align: center;"> <div style="display: flex; justify-content: space-around; margin-bottom: 5px;"> <div style="border: 1px solid black; padding: 2px; text-align: center;">△</div> <div style="border: 1px solid black; padding: 2px; text-align: center;">▶</div> </div> <div style="display: flex; justify-content: space-around; margin-bottom: 5px;"> <div style="border: 1px solid black; padding: 2px; text-align: center;">PRINT</div> <div style="border: 1px solid black; padding: 2px; text-align: center;">FEED</div> </div> </div>	<p>Use the △ key to select a numeral. Use the ◦ key to shift a digit.</p>
<div style="display: flex; align-items: center;"> <div style="border: 1px solid black; width: 30px; height: 30px; margin-right: 10px; display: flex; align-items: center; justify-content: center;"> <span>.</span> </div> <div style="border: 1px solid black; padding: 5px; display: flex; justify-content: space-around; width: 150px;"> <span>. . . . .</span> </div> </div> <p style="margin-top: 5px;">(Decimal point)</p>	<div style="text-align: center;"> <div style="display: flex; justify-content: space-around; margin-bottom: 5px;"> <div style="border: 1px solid black; padding: 2px; text-align: center;">▶</div> <div style="border: 1px solid black; padding: 2px; text-align: center;">△</div> </div> <div style="display: flex; justify-content: space-around; margin-bottom: 5px;"> <div style="border: 1px solid black; padding: 2px; text-align: center;">FEED</div> <div style="border: 1px solid black; padding: 2px; text-align: center;">PRINT</div> </div> <div style="border: 1px solid black; padding: 2px; text-align: center; width: 40px; margin: 0 auto;">ENT</div> </div>	<p>Press the ◦ key again in the lowest digit(right end) to blink a decimal point. Use the △ key to select a decimal point position. Press the “ENT” key.</p>
<div style="display: flex; align-items: center;"> <div style="border: 1px solid black; width: 30px; height: 30px; margin-right: 10px; display: flex; align-items: center; justify-content: center;"> <span>.</span> </div> <div style="border: 1px solid black; padding: 5px; display: flex; justify-content: space-around; width: 150px;"> <span>. . . . .</span> </div> </div> <p style="margin-top: 5px;">(Span-side scale value)</p>	<div style="text-align: center;"> <div style="display: flex; justify-content: space-around; margin-bottom: 5px;"> <div style="border: 1px solid black; padding: 2px; text-align: center;">△</div> <div style="border: 1px solid black; padding: 2px; text-align: center;">▶</div> </div> <div style="display: flex; justify-content: space-around; margin-bottom: 5px;"> <div style="border: 1px solid black; padding: 2px; text-align: center;">PRINT</div> <div style="border: 1px solid black; padding: 2px; text-align: center;">FEED</div> </div> <div style="border: 1px solid black; padding: 2px; text-align: center; width: 40px; margin: 0 auto;">ENT</div> </div>	<p>Use the △ key to select a numeral. Use the ◦ key to shift a digit. Press the “ENT” key.</p>
<div style="display: flex; align-items: center;"> <div style="border: 1px solid black; width: 30px; height: 30px; margin-right: 10px;"></div> <div style="border: 1px solid black; padding: 5px; display: flex; justify-content: space-around; width: 150px;"> <span>. . . . .</span> </div> </div>	<div style="text-align: center;"> <div style="border: 1px solid black; padding: 2px; text-align: center; width: 40px;">ENT</div> </div>	<p>Press the “ENT” key. Setting is completed. To return to the user mode, hold down the “MENU” key for 3 seconds or more.</p>

**[Note]**  
 An entry of an incorrect numeral displays errors . . . . . or . . . . . or . . . . ..  
 Press the “ENT” key and re-enter a correct numeral.

### **About Square Root Computation**

The square root computation is as follows:

- Each item is defined as follows:
  - SPAN<sub>L</sub> : Span lower-limit value (Span L)
  - SPAN<sub>R</sub> : Span upper-limit value (Span R)
  - SCAL<sub>L</sub> : Scaling lower-limit value (Scale L)
  - SCAL<sub>R</sub> : Scaling upper-limit value (Scale R)
  - IN : Input voltage
  - OUT : Output (Scaling value)

- When an input value is 1 % or more (1 to 100 %)

$$OUT = (SCAL_R - SCAL_L) \times \sqrt{\frac{IN - SPAN_L}{SPAN_R - SPAN_L}} + SCAL_L$$

- When an input value is less than 1 %

$$OUT = \frac{10 \times (SCAL_R - SCAL_L)}{SPAN_R - SPAN_L} \times (IN - SPAN_L) + SCAL_L$$

Example) When makes setting in previous page, the display is as follow table.

Input voltage (mV)	0	10	20	30	40
Display (%)	0.00	50.00	70.71	86.63	100.00

#### **[Note]**

The relation between scaling factor and displaying digit may stagger the accuracy rating.

**(5) . . . . . (Decade)**

Scaling the VOLT input and displays the index number. Setting the unit is possible. (See 7.1.3 on page 58)

Example) When setting the voltage of 0 to 5 V and decade of  $1.0 \times 10^0$  to  $1.0 \times 10^5$  for Channel 1.

Display	Operation keys	Description
<div style="display: flex; align-items: center;"> <div style="border: 1px solid black; width: 30px; height: 30px; margin-right: 10px;"></div> <div style="border: 1px solid black; padding: 5px; display: flex; justify-content: space-around; width: 150px;"> <span>. . . . .</span> </div> </div>	<div style="text-align: center; margin-bottom: 5px;">ESC</div> <div style="display: flex; justify-content: space-between;"> <div style="border: 1px solid black; padding: 2px 5px;">MENU</div> <div>3sec</div> </div> <div style="display: flex; justify-content: space-around; margin-top: 5px;"> <div style="border: 1px solid black; padding: 2px 5px;">PRINT</div> <div style="border: 1px solid black; padding: 2px 5px;">ENT</div> </div>	<p>Hold down the “MENU” key for 3 seconds or more to enter the setup mode. Use the <math>\Delta</math> key to display ". . . . .". Press the “ENT” key.</p>
<div style="display: flex; align-items: center;"> <div style="border: 1px solid black; width: 30px; height: 30px; margin-right: 10px;"></div> <div style="border: 1px solid black; padding: 5px; display: flex; justify-content: space-around; width: 150px;"> <span>. . .</span> </div> </div>	<div style="display: flex; justify-content: space-around; margin-top: 5px;"> <div style="border: 1px solid black; padding: 2px 5px;">PRINT</div> <div style="border: 1px solid black; padding: 2px 5px;">ENT</div> </div>	<p>Use the <math>\Delta</math> key to select the channel you want to set. Press the “ENT” key.</p>
<div style="display: flex; align-items: center;"> <div style="border: 1px solid black; width: 30px; height: 30px; margin-right: 10px;"></div> <div style="border: 1px solid black; padding: 5px; display: flex; justify-content: space-around; width: 150px;"> <span>. . . . .</span> </div> </div>	<div style="display: flex; justify-content: space-around; margin-top: 5px;"> <div style="border: 1px solid black; padding: 2px 5px;">PRINT</div> <div style="border: 1px solid black; padding: 2px 5px;">ENT</div> </div>	<p>Use the <math>\Delta</math> key to select ". . . . .". Press the “ENT” key.</p>
<div style="display: flex; align-items: center;"> <div style="border: 1px solid black; width: 30px; height: 30px; margin-right: 10px;"></div> <div style="border: 1px solid black; padding: 5px; display: flex; justify-content: space-around; width: 150px;"> <span>. .</span> </div> </div>	<div style="display: flex; justify-content: space-around; margin-top: 5px;"> <div style="border: 1px solid black; padding: 2px 5px;">PRINT</div> <div style="border: 1px solid black; padding: 2px 5px;">ENT</div> </div>	<p>Use the <math>\Delta</math> key to select a range(5V). Press the “ENT” key.</p>
<div style="display: flex; align-items: center;"> <div style="border: 1px solid black; width: 30px; height: 30px; margin-right: 10px; display: flex; align-items: center; justify-content: center;"> <span>.</span> </div> <div style="border: 1px solid black; padding: 5px; display: flex; justify-content: space-around; width: 150px;"> <span>. . . . .</span> </div> </div> <p style="margin-top: 5px;">(Zero input value)</p>	<div style="display: flex; justify-content: space-around; margin-top: 5px;"> <div style="border: 1px solid black; padding: 2px 5px;">PRINT</div> <div style="border: 1px solid black; padding: 2px 5px;">FEED</div> </div> <div style="border: 1px solid black; padding: 2px 5px; margin-top: 5px; width: 40px;">ENT</div>	<p>Use the <math>\Delta</math> key to select a numeral. Use the <math>\cdot</math> key to shift a digit. Press the “ENT” key.</p>
<div style="display: flex; align-items: center;"> <div style="border: 1px solid black; width: 30px; height: 30px; margin-right: 10px; display: flex; align-items: center; justify-content: center;"> <span>.</span> </div> <div style="border: 1px solid black; padding: 5px; display: flex; justify-content: space-around; width: 150px;"> <span>. . . . .</span> </div> </div> <p style="margin-top: 5px;">(Span input value)</p>	<div style="display: flex; justify-content: space-around; margin-top: 5px;"> <div style="border: 1px solid black; padding: 2px 5px;">PRINT</div> <div style="border: 1px solid black; padding: 2px 5px;">FEED</div> </div> <div style="border: 1px solid black; padding: 2px 5px; margin-top: 5px; width: 40px;">ENT</div>	<p>Use the <math>\Delta</math> key to select a numeral. Use the <math>\cdot</math> key to shift a digit. Press the “ENT” key.</p>
<div style="display: flex; align-items: center;"> <div style="border: 1px solid black; width: 30px; height: 30px; margin-right: 10px; display: flex; align-items: center; justify-content: center;"> <span>.</span> </div> <div style="border: 1px solid black; padding: 5px; display: flex; justify-content: space-around; width: 150px;"> <span>. . . . .</span> </div> </div> <p style="margin-top: 5px;">(Zero-side scale value)</p>	<div style="display: flex; justify-content: space-around; margin-top: 5px;"> <div style="border: 1px solid black; padding: 2px 5px;">PRINT</div> <div style="border: 1px solid black; padding: 2px 5px;">FEED</div> </div> <div style="border: 1px solid black; padding: 2px 5px; margin-top: 5px; width: 40px;">ENT</div>	<p>Use the <math>\Delta</math> key to select a numeral. Use the <math>\cdot</math> key to shift a digit. Press the “ENT” key.</p>
<div style="display: flex; align-items: center;"> <div style="border: 1px solid black; width: 30px; height: 30px; margin-right: 10px; display: flex; align-items: center; justify-content: center;"> <span>.</span> </div> <div style="border: 1px solid black; padding: 5px; display: flex; justify-content: space-around; width: 150px;"> <span>. . . . .</span> </div> </div> <p style="margin-top: 5px;">(Span-side scale value)</p>	<div style="display: flex; justify-content: space-around; margin-top: 5px;"> <div style="border: 1px solid black; padding: 2px 5px;">PRINT</div> <div style="border: 1px solid black; padding: 2px 5px;">FEED</div> </div> <div style="border: 1px solid black; padding: 2px 5px; margin-top: 5px; width: 40px;">ENT</div>	<p>Use the <math>\Delta</math> key to select a numeral. Use the <math>\cdot</math> key to shift a digit. Press the “ENT” key.</p>
<div style="display: flex; align-items: center;"> <div style="border: 1px solid black; width: 30px; height: 30px; margin-right: 10px;"></div> <div style="border: 1px solid black; padding: 5px; display: flex; justify-content: space-around; width: 150px;"> <span>. . . . .</span> </div> </div>	<div style="border: 1px solid black; padding: 2px 5px; margin-top: 5px; width: 40px;">ENT</div>	<p>Press the “ENT” key. Setting is completed. To return to the user mode, hold down the “MENU” key for 3 seconds or more.</p>

**[Note]**  
An entry of an incorrect numeral displays errors . . . . . or . . . . . or . . . . ..  
Press the “ENT” key and re-enter a correct numeral.

### About Decade Display

- Each item is defined as follows:

SPAN <sub>L</sub>	: Span lower-limit value (Span L)	
SPAN <sub>R</sub>	: Span upper-limit value (Span R)	
SCAL <sub>L</sub>	: Scaling lower-limit value (Scale L)	} XXEYY
SCAL <sub>R</sub>	: Scaling upper-limit value (Scale R)	
IN	: Input voltage	
OUT	: Output (Scaling value)	

XX: Mantissa section (1.0 to 9.9)

YY: Exponent section (-19 to 19)

Up to 5 decades.

(Scaling upper limit) – (Scaling lower limit) is 1.0E5 or less.

- Decade display abides by the following relational expression.

$$OUT1 = IN \times \frac{LG\ SCAL_R - LG\ SCAL_L}{SPAN_R - SPAN_L} + \frac{SPAN_R \times LGSCAL_L - SPAN_L \times LGSCAL_R}{SPAN_R - SPAN_L}$$

$$OUT = 10^{OUT1}$$

LG SCAL<sub>L</sub> :Log<sub>10</sub>(SCAL<sub>L</sub>)

LG SCAL<sub>R</sub> :Log<sub>10</sub>(SCAL<sub>R</sub>)

#### **[Note]**

Decade output is used for display and print. It is not reflected on a printing position.

Example) When makes setting in previous page, the display is as follow table.

Input voltage (V)	0. 0	1. 0	2. 5	3. 0	5. 0
Display	1. 0E0	1. 0E1	3. 2E2	1. 0E3	1. 0E5

**(6) . . . . (Difference), . . . . (Sum), . . . . (Average)**

Calculates the input of VOLT, TC, RTD or SCALE, and output.

Example) When subtracting the Ch 1 input data from the Ch 6 input data to set the difference (0 to 40 mV). Records and displays on Ch 6 "Ch 6 (input) - Ch 1(input)".

Display	Operation keys	Description
<input type="checkbox"/> . . . . .	<sup>ESC</sup> MENU 3sec PRINT ENT	Hold down the "MENU" key for 3 seconds or more to enter the setup mode. Use the Δ key to display ". . . . .". Press the "ENT" key.
<input type="checkbox"/> . . . (Setting channel)	Δ PRINT ENT	Use the Δ key to select the channel you want to set. Press the "ENT" key.
<input type="checkbox"/> . . . . .	Δ PRINT ENT	Use the Δ key to select ". . . . .". Press the "ENT" key.
<input type="checkbox"/> . . . (Reference channel)	Δ PRINT ENT	Use the Δ key to select the "channel you want to subtract." Press the "ENT" key.
<input type="checkbox"/> . . . . . (Zero input value after difference operation)	Δ PRINT FEED ENT	Use the Δ key to select a numeral. Use the · key to shift a digit. Press the "ENT" key.
<input type="checkbox"/> . . . . . (Span input value after difference operation)	Δ PRINT FEED ENT	Use the Δ key to select a numeral. Use the · key to shift a digit. Press the "ENT" key.
<input type="checkbox"/> . . . . .	ENT	Press the "ENT" key. Setting is completed. To return to the user mode, hold down the "MENU" key for 3 seconds or more.

**[Note]**  
An entry of an incorrect numeral displays errors  . . . . . or  . . . . . or  . . . . . .  
Press the "ENT" key and re-enter a correct numeral.

**About Difference, Sum, and Average**

- The channel to be set must be larger than the one on which computes the "difference, sum, or average".  
When setting Channel 6, for example, you can subtract the Channel 1 to 5 value.
- The range and scale of the set channel is the same as the channel on which computes the "difference, sum, and average".
- A range value after the computation cannot exceed the maximum range of the instrument.
- Set for the reference channel only the voltage, current, thermocouple, resistance temperature detector, and their scaling ranges.

**(7) . . . . (Skip)**

Setting SKIP on the Channel does not display and recording.

Example) When skipping Channel 6.

Display	Operation keys	Description
<input type="checkbox"/> . . . . .	<input type="button" value="MENU"/> 3sec <input type="button" value="△"/> <input type="button" value="PRINT"/> <input type="button" value="ENT"/>	Hold down the "MENU" key for 3 seconds or more to enter the setup mode. Use the △ key to display ". . . . .". Press the "ENT" key.
<input type="checkbox"/> . . .	<input type="button" value="△"/> <input type="button" value="PRINT"/> <input type="button" value="ENT"/>	Use the △ key to select the channel you want to set. Press the "ENT" key.
<input type="checkbox"/> . . . .	<input type="button" value="△"/> <input type="button" value="PRINT"/> <input type="button" value="ENT"/>	Use the △ key to select ". . . .". Press the "ENT" key.
<input type="checkbox"/> . . . . .	<input type="button" value="ENT"/>	Press the "ENT" key. Setting is completed. To return to the user mode, hold down the "MENU" key for 3 seconds or more.

**[Note]**

- Setting all the channels to Skip displays an error,  . . . . . .  
At least, one channel should be set to measurement.
- The skip channel conducts measurement, but does not provide display, print, or alarm judgment. If input is not connected, short-circuit a measurement terminal.
- It is not possible to return it based on the setting skipped once. Please set range again.



## 7.1.2 Setting the Alarm

### Setting items

Alarm setting to the following two types for each channel is possible.

Alarm point can set up 4 levels for each channel.

Once sets up the alarm point, illuminated "ALM" when a process variable reaches alarm point, and simultaneously, outputs the alarm print indicating an alarm occurrence to the chart paper.

- : Upper-limit alarm ---- When the process variable is higher than the alarm set point, issues an alarm.
- : Lower-limit alarm ---- When the process variable is lower than the alarm set point, issues an alarm.

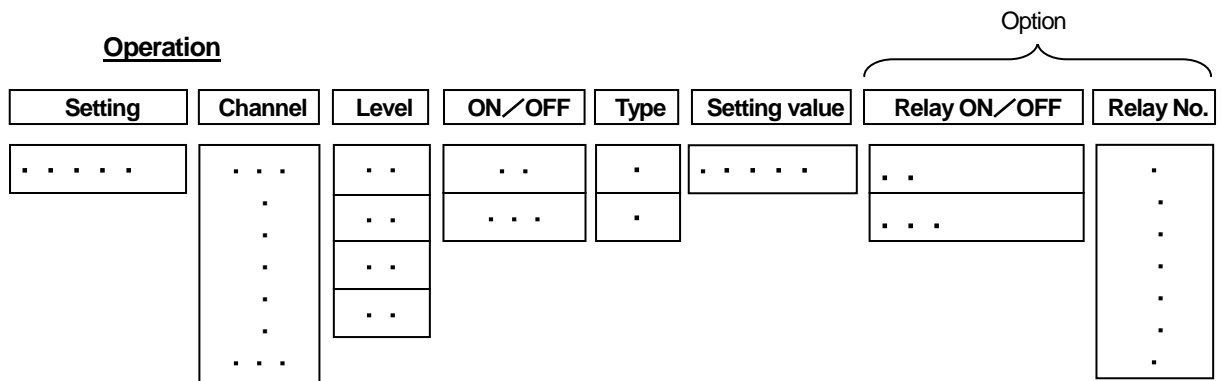

Example) When setting for the Channel 1 alarm point (Level 1) the upper-limit alarm, set value of -2.000, and alarm output relay No. 1.

Display	Operation keys	Description
□    • • • • •	<sup>ESC</sup> MENU 3sec ▲ PRINT    ENT	Hold down the "MENU" key for 3 seconds or more to enter the setup mode. Use the ▲ key to display "• • • • •". Press the "ENT" key.
□    • • •	▲ PRINT    ENT	Use the ▲ key to select the channel you want to set. Press the "ENT" key.
□    • •	▲ PRINT    ENT	Use the ▲ key to select an alarm level. Press the "ENT" key. Up to 4 levels can be set.
□    • •	▲ PRINT    ENT	Use the ▲ key to select alarm setting ON. Press the "ENT" key. Setting "• • •" displays "• • • • •" and completes setting.
□    •	▲ PRINT    ENT	Use the ▲ key to select an alarm type. Press the "ENT" key.
□    • • • • •	▲    ▶ PRINT    FEED ENT	Set an alarm point. Use the • key to shift a digit, and use the ▲ key to select a numeral. Once setting is completed, press the "ENT" key. A decimal point position is fixed depending on the range.

**[Note]**

When the "ENT" key is pressed in setting the alarm point. Display will be switched to the next setting display.

Setting hereinafter is valid only for the model to which an alarm output relay option has been attached. If the option has not been set, press the "ENT" key until ". . . . ." is displayd.

Then, press the "ENT" key once more. Setting is completed.

Display	Operation keys	Description
<div style="display: flex; align-items: center;"> <div style="border: 1px solid black; width: 30px; height: 30px; margin-right: 10px; display: flex; align-items: center; justify-content: center;">.</div> <div style="border: 1px solid black; width: 140px; height: 30px; display: flex; align-items: center; justify-content: center;">. .</div> </div>	<div style="display: flex; align-items: center; justify-content: center;"> <div style="text-align: center; margin-right: 5px;">△ PRINT</div> <div style="margin-right: 5px;">ENT</div> </div>	<p>When an alarm occurs, issues the alarm output from the alarm output relay. Use the △ key to select alarm output ON and press the "ENT" key.</p> <p>If the alarm output is not used, select OFF and press the "ENT" key.</p>
<div style="display: flex; align-items: center;"> <div style="border: 1px solid black; width: 30px; height: 30px; margin-right: 10px; display: flex; align-items: center; justify-content: center;">.</div> <div style="border: 1px solid black; width: 140px; height: 30px; display: flex; align-items: center; justify-content: center;">.</div> </div>	<div style="display: flex; align-items: center; justify-content: center;"> <div style="text-align: center; margin-right: 5px;">△ PRINT</div> <div style="margin-right: 5px;">ENT</div> </div>	<p>If the alarm output is set to ON, set the relay number. Use the △ key to select the relay number out of 1 to 6, and press the "ENT" key.</p>
<div style="display: flex; align-items: center;"> <div style="border: 1px solid black; width: 30px; height: 30px; margin-right: 10px;"></div> <div style="border: 1px solid black; width: 140px; height: 30px; display: flex; align-items: center; justify-content: center;">. . . . .</div> </div>	<div style="display: flex; align-items: center; justify-content: center;"> <div style="margin-right: 5px;">ENT</div> </div>	<p>Press the "ENT" key. Setting is completed.</p> <p>When you want to continue to set for other channel, press the △ key to select the channel, and start setting. To return to the user mode, hold down the "MENU" key for 3 seconds or more.</p>

**[Note]**

The tag setting does not effect on Alarm print setting. Prints channel numbers every time.

### 7.1.3 Setting the Unit

#### Setting Items

Set the unit for each channel.

**[Note]**  
If you change the unit in the range of . . . . , . . . or . . . . , setting the range to . . . . .

#### Operation

Setting	Channel	Char. No.	Code No.
. . . .	. . . .	.	. . . . (°)
	.	.	. . . . (C)
	.	.	. . . . End
	.	.	
	.	.	
	. . . .	.	

Example) Setting the unit(°C) for Channel 1.

Display	Operation keys	Description
<input type="checkbox"/> . . . .	<sup>ESC</sup> MENU 3sec PRINT ENT	Hold down the "MENU" key for 3 seconds or more to enter the setup mode. Use the Δ key to display ". . . .". Then, press the "ENT" key.
<input type="checkbox"/> . . .	PRINT ENT	Use the Δ key to select the channel you want to set. Then, press the "ENT" key.
<input type="checkbox"/> . . . . (Code No.)	PRINT FEED ENT	Use the Δ or . key to select the 1st character of the code number, and press the "ENT" key. See Characters Code Table on the next page.
<input type="checkbox"/> . . . .	PRINT FEED ENT	Set the 2nd character in the same manner.
<input type="checkbox"/> . . . .	PRINT FEED ENT	When the number of unit characters is less than 6, enter a code(. . .) to end. Press the "ENT" key.
<input type="checkbox"/> . . . . .	ENT	Press the "ENT" key. Setting is completed. To return to the user mode, hold down the "MENU" key for 3 seconds or more.

**[Note]**  
The unit setting effects only when the range setting is . . . . . , . . . . . or . . . . . (including . . . . , . . . . . and . . . . . selected . . . . . as the reference channel).  
When the range setting is others, the unit sets appropriate unit for the range automatically.

**(1) Character Code Table**

	2*	3*	4*	5*	6*	7*	A*	B*	C*	D*	E*	F*
*0	SP	0	@	P		p	o	o		Π		π
*1	!	1	A	Q	a	q	1	1	A	P	α	ρ
*2	"	2	B	R	b	r	2	2	B	Σ	β	σ
*3	#	3	C	S	c	s	3	3	Γ	T	γ	τ
*4	\$	4	D	T	d	t	4	4	Δ	Υ	δ	υ
*5	%	5	E	U	e	u	5	5	E	Φ	ε	φ
*6	&	6	F	V	f	v	6	6	Z	X	ζ	χ
*7	'	7	G	W	g	w	7	7	H	Ψ	η	ψ
*8	(	8	H	X	h	x	8	8	Θ	Ω	θ	ω
*9	)	9	I	Y	i	y	9	9	I		ι	
*A	*	:	J	Z	j	z			K		κ	
*B	+	;	K	[	k	{	+	+	Λ		λ	
*C	,	<	L	¥	l		±	〒	M	△	μ	
*D	-	=	M	]	m	}			N	▲	ν	
*E	.	>	N	^	n	—	-	-	≡	▽	ξ	
*F	/	?	O	_	o		o	o	O	▴	o	

Example) The code number for "C" is "43".

### 7.1.4 Setting the Chart Speed

#### Setting Items

Set the chart speed. Select it from the table below.

Table 7.2 Chart Speed (Unit: mm/h)

0	1	2	3	4	5	10	15	20	25
30	40	50	60	75	80	90	100	120	150
160	180	200	240	300	360	375	450	600	720
750	900	1200	1500						

#### Operation

Setting	1st/2nd Chart speed	Chart speed
. . . . .	. . . . . . . . . .	. . . . .

Example) When setting the 1st chart speed to 1500 mm/h.

Display	Operation keys	Description
<input type="checkbox"/> . . . . .	<input type="checkbox"/> <sup>ESC</sup> MENU 3sec <input type="checkbox"/> <sup>△</sup> PRINT    ENT	Press the "MENU" key for 3 seconds or more to enter the setup mode. Use the △ key to display ". . . . .", and press the "ENT" key.
<input type="checkbox"/> . . . . .	<input type="checkbox"/> <sup>△</sup> PRINT    ENT	Use the △ key to select the 1st chart speed, and press the "ENT" key.

**[Note]**  
When altering the chart speed with the DI option, set the 2nd chart speed.  
If the DI option is not attached, setting of the 2nd chart speed becomes invalid.

Display	Operation keys	Description
<input type="checkbox"/> . . . . .	<input type="checkbox"/> <sup>△</sup> PRINT    ENT	Use the △ key to set the 1st chart speed, and press the "ENT" key.
<input type="checkbox"/> . . . . .	<input type="checkbox"/> ENT	Press the "ENT" key. To return to the user mode, hold down the "MENU" key for 3 seconds or more.

<b>[Note]</b> Restriction of printing by chart speed	Print type	Chart speed (mm/h)
	Alarm occurrence print, Alarm recovery print, Affix print, DI Comment print (Sync.), DI Date and Time print (Sync.), DI Manual print (Sync.), Record Start/End Print(Sync.)	1~100
	Logging print (Sync.)	10~100

When the chart speed is 0 mm/h, it's printed with forcible chart feed. (When the chart speed is more than 120 mm/h, not printing as shown the Table above.) List Print, Engineering List Print , Manual Print (key), DI Comment print (ASync.) , DI Date and Time print (ASync.) , DI Manual print (ASync.) , Logging print (ASync.)

### 7.1.5 Setting the Date and Time

#### Operation

The following describes how to set the date/time of the internal clock.

Setting	Year	Month, Day	Time
. . . . .	. . . . .	. . . . .	. . . . .

Example) When setting the date and time to January 1st, 2000, 6:00.

Display	Operation keys	Description
[ ] [ . . . . . ]	<sup>ESC</sup> MENU 3sec	Hold down the "MENU" key for 3 seconds or more to enter the setup mode. Use the Δ key to display ". . . . .," and press the "ENT" key.
[ . ] [ . . . . . ]	PRINT ENT	Set the year. Use the Δ key to select a numeral, and use the . key to shift a digit. Press the "ENT" key.
[ . ] [ . . . . . ]	PRINT FEED ENT	Set the month and day. Operate in the same manner as setting the year.
[ . ] [ . . . . . ]	PRINT FEED ENT	Set the time (hours and minutes). Operate in the same manner as setting the year.
[ ] [ . . . . . ]	ENT	Press the "ENT" key. To return to the user mode, hold down the "MENU" key for 3 seconds or more.

<b>[Note]</b>
If you enter a non-existent dates or time, displays an error [ . ] [ . . . . . ] .
Press the "ENT" key and re-enter a correct numeral.

## 7.1.6 Copying the Setting Data

### Setting Items

The following describes how to copy the setting data of any channel to other channel.

The copy-to channel must be bigger than the copy-from channel.

### Operation

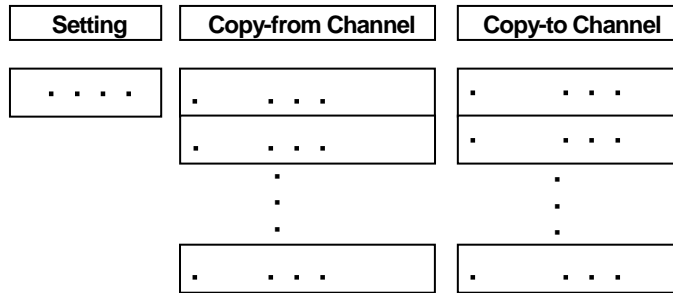

Example) When copying the setting data of Channel 1 to Channel 2.

Display	Operation keys	Description
<input type="checkbox"/> . . . .	<sup>ESC</sup> MENU 3sec	Hold down the "MENU" key for 3 seconds or more to enter the setup mode. Use the Δ key to display ". . . .", and press the "ENT" key.
<input type="checkbox"/> . . . .	Δ PRINT ENT	Use the Δ key to select the copy-from channel, and press the "ENT" key.
<input type="checkbox"/> . . . .	Δ PRINT ENT	Use the Δ key to select the copy-to channel, and press the "ENT" key.
<input type="checkbox"/> . . . .	ENT	Press the "ENT" key. To return to the user mode, hold down the "MENU" key for 3 seconds or more.

### 7.1.7 Setting Other Functions

Setting other functions as follows is possible.

#### Setting Items

① . . . . . (Printing cycle)

Select a printing cycle from among 10, 20, 30, and 60 seconds.

② . . . . . (Zone recording)

The data for each channel can be recorded separately in another area so that they will not overlap.

③ . . . . . (Partial compression/expansion)

Record the measured data of the channel, partially compressed/expanded.

④ . . . . . (Digital print)

Specify with ON/OFF whether the measured data for each channel is to be printed or not.

⑤ . . . . . (Tag)

Set the tag, which is to be printed instead of a channel number, for logging print or manual print.

Setting up to 7 characters (select from character code table on page 59), as the tag for each channel is possible.

⑥ . . . . . (Comment words)

Set the comment words to be printed by DI. There are three kinds of comment words and setting up to 16 characters (select from character code table on page 59) for each DI is possible.

#### Operation

Setting	Mode	
. . . .	. .	Printing Cycle Zone Recording Partial Compression/Expansion Digital Print Tag Comment Words



**(1) . . . . (Printing Cycle)**

Example) When setting the printing cycle to 60 seconds.

Display	Operation keys	Description
		Hold down the "MENU" key for 3 seconds or more to enter the setup mode. Use the $\Delta$ key to display ". . .", and press the "ENT" key.
		Use the $\Delta$ key to display ". . . .", and press the "ENT" key.
		Use the $\Delta$ key to select the printing cycle ". .", and press the "ENT" key.
		Press the "ENT" key. Setting is completed. To return to the user mode, hold down the "MENU" key for 3 seconds or more.

**(2) . . . . (Zone Recording)**

Example) When setting the instrument so that Channel 1 zero/span will be recorded at the position of 20 to 50 %.

Display	Operation keys	Description
		Hold down the "MENU" key for 3 seconds or more to enter the setup mode. Use the $\Delta$ key to display ". . .", and press the "ENT" key.
		Use the $\Delta$ key to display ". . . .", and press the "ENT" key.
		Use the $\Delta$ key to select the channel you want to set, and press the "ENT" key.
		Set a zero point printing position in percentage (%). Use the $\Delta$ key to select a numeral, and use the $\cdot$ key to shift a digit. Press the "ENT" key.
		Set a span printing position in percentage (%). Operate in the same manner as setting the zero point printing position.
		Set a span printing position in percentage (%). Operate in the same manner as setting the zero point printing position.
		Press the "ENT" key. Setting is completed. To return to the user mode, hold down the "MENU" key for 3 seconds or more.

**[Note]**  
 If you enter an incorrect numeral, displays errors or .  
 Press the "ENT" key and re-enter a correct numeral.

**(3) . . . . (Partial Compression/Expansion)**

Example) When setting Channel 1 scale of 0 to 1,000.0 °C to 500.0 °C at a boundary point of 30 %.

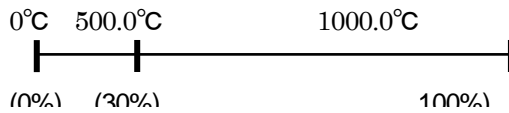

Display	Operation keys	Description
<input type="checkbox"/> . . .	<sup>ESC</sup> MENU 3sec PRINT ENT	Hold down the "MENU" key for 3 seconds or more to enter the setup mode. Use the Δ key to display ". . .", and press the "ENT" key.
<input type="checkbox"/> . . . .	PRINT ENT	Use the Δ key to select ". . . .", and press the "ENT" key.
<input type="checkbox"/> . . .	PRINT ENT	Use the Δ key to select the channel you want to set, and press the "ENT" key.
<input type="checkbox"/> . .	PRINT ENT	Use the Δ key to select ". .", and press the "ENT" key.
<input type="checkbox"/> . . .	PRINT FEED ENT	Set a boundary point position in percentage (%). Use the Δ key to select a numeral, and use the . key to shift a digit. Press the "ENT" key.
<input type="checkbox"/> . . . . .	PRINT FEED ENT	Set a boundary point position to "0500.0". Use the Δ key to select a numeral, and use the . key to shift a digit. Press the "ENT" key.
<input type="checkbox"/> . . . . .	ENT	Press the "ENT" key. Setting is completed. To return to the user mode, hold down the "MENU" key for 3 seconds or more.

**[Note]**  
 If you enter an incorrect numeral, displays an error  . . . . .  
 Press the "ENT" key and re-enter a correct numeral.

**(4) . . . . . (Digital Print)**

Example) When setting logging channel data print to "ON"(print enabled) for all the channels.







Display	Operation keys	Description
□ . . .	<sup>ESC</sup> MENU 3sec △ PRINT ENT	Hold down the "MENU" key for 3 seconds or more to enter the setup mode. Use the △ key to display ". . .", and press the "ENT" key.
□ . . . . .	△ PRINT ENT	Use the △ key to display ". . . . .", and press the "ENT" key.
□ . . .	△ PRINT ENT	Use the △ key to select the channel you want to set, and press the "ENT" key.
□ . .	△ PRINT ENT	Use the △ key to switch from ". . . ." to ". . .", and press the "ENT" key.
□ . . . . .	ENT	Press the "ENT" key. Setting is completed.
□ . . .	△ PRINT ENT	To return to the user mode, hold down the "MENU" key for 3 seconds or more.
□ . . .	△ PRINT ENT	
□ . . . . .	ENT	

Repeat setting for each channel.

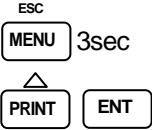
**[Note]**  
 The data for the channel to be skipped is printed "\*".

**(5) . . . (Tag)**

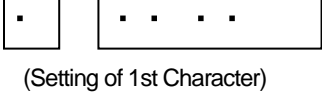
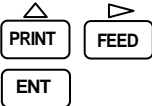
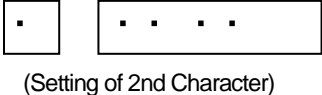
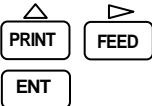
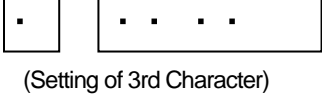
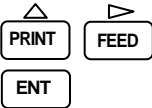
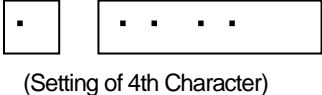
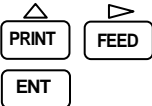
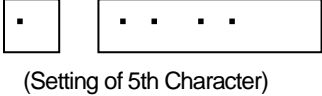
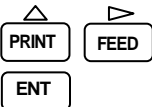
Example) When setting "ABCD" for Channel 1.

Display	Operation keys	Description
		Hold down the "MENU" key for 3 seconds or more to enter the setup mode. Use the $\Delta$ key to display ". . .", and press the "ENT" key.
		Use the $\Delta$ key to display ". . .", and press the "ENT" key.
		Use the $\Delta$ key to select the channel you want to set, and press the "ENT" key.
 (Setting of 1st Character)		Set ". ." as the 1st character. Use the $\Delta$ key to select a code, and use the $\cdot$ key to shift a digit. Press the "ENT" key.
 (Setting of 2nd Character)		} Set the 2nd through 4th characters in the same manner.
 (Setting of 3rd Character)		
 (Setting of 4th Character)		
 (Setting of 5th Character)		Set ". ." as the 5th character and press the "ENT" key.
		Press the "ENT" key. Setting is completed. To return to the user mode, hold down the "MENU" key for 3 seconds or more.

**[Note]**  
When the number of tag characters is less than 7, set the ". ." code next to the last characters. See page 55 for details.

**(6) . . . . (Comment Words)**

Example) When setting "ON" for Comment 1(. . . .).

Display	Operation keys	Description
		Hold down the "MENU" key for 3 seconds or more to enter the setup mode. Use the Δ key to display ". . .", and press the "ENT" key.
		Use the Δ key to display ". . . .", and press the "ENT" key.
		Use the Δ key to select a comment number. Display ". . . ." and press the "ENT" key.
 (Setting of 1st Character)		Set ". . ." as the 1st character. Use the Δ key to select a code, and use the . key to shift a digit. Press the "ENT" key.
 (Setting of 2nd Character)		Set ". . ." as the 2nd character. Operate in the same manner as setting the 1st character to end.
 (Setting of 3rd Character)		Set ". . ." as the 3rd character. Operate in the same manner as setting the 1st character.
 (Setting of 9th Character)	}	Repeat setting for each channel.
 (Setting of 10th Character)		
 (Setting of 11th Character)		
 (Setting of 16th Character)		
 ENT		Press the "ENT" key. Setting is completed. To return to the user mode, hold down the "MENU" key for 3 seconds or more.

**[Note]**

- When the number of comment characters is less than 16, set the ". . ." code next to the last characters. See page 59 for Character Code Table.
- The digit is not display after setting the ". . .".
- The comment setting is not effective without the DI option. Do not set the comment setting.

## 7.2 Setting the Engineering Mode

### Key Operation to Enter the Engineering Mode

Hold down the "MENU" key for 3 seconds or more to enter the setup mode.

Use the  $\Delta$  key to select ". . . .", and press the "ENT" key then to display "0000".

Use the  $\Delta$  key to alter a numeral, and the  $\cdot$  key to shift a digit, enter the password "2222".

Press the "ENT" key then to display blinking ". . . . .".

Press the "ENT" key. After reset, enter the engineering mode.

The following describes how to set the following items.

The following shows a display map of the Engineering mode. Use the  $\Delta$  key to operate.

- 7.2.1 Alarm Hysteresis

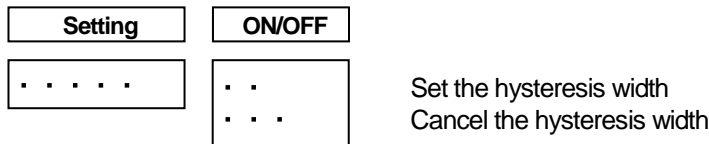

- 7.2.2 Burnout ON/OFF

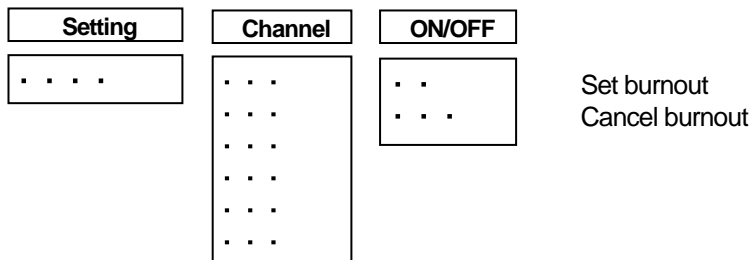

- 7.2.3 Channel Offset

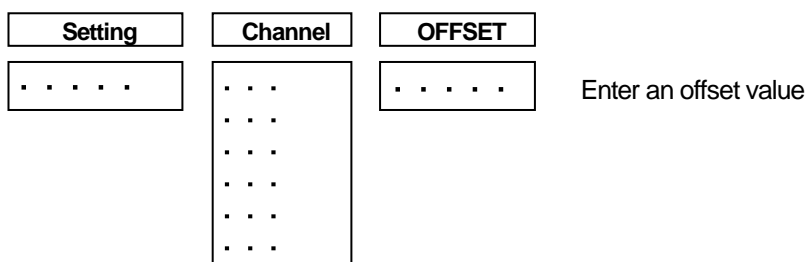

- 7.2.4 Reference Junction Compensation

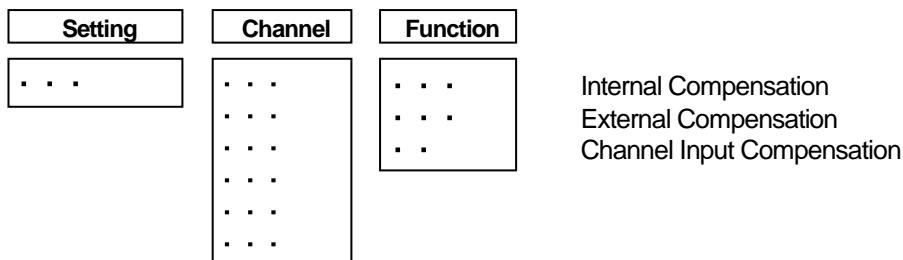

● 7.2.5 Changing the Printing Color

Setting	Channel	COLOR
. . . . .	. . . . . . . . . . . . . . . . . .	. . . . . . . . . . . . . . . . . .

Purple  
Red  
Green  
Blue  
Brown  
Black

● 7.2.6 Settings Related to Recording

Setting	Function
. . .	. .

Recording start/stop INT/EXT selection  
Tag/channel print selection  
Alarm print ON/OFF  
Logging print ON/OFF  
Scale prints ON/OFF  
Record Start/End print OFF/SYNC/ASYNC

● 7.2.7 Setting the Communication Function

Setting	Setting the Communication Function
. . .	Protocol Selection Local Address Baud Rate Data Length Parity Bit Stop Bit

● 7.2.8 Initializing the Setup Data and Calibration Data

Setting	YES/NO
. . . . .	. . . . . . . . .

Initialize the Setup Mode  
Is reset to the factory default calibration value.

● 7.2.9 DI Functions

Setting	DI No.	Function
. .	. . . . . . . . .	. .

No function  
Recording start/stop  
Chart speed selection  
Comment 1 print(Synchronous)  
Comment 2 print(Synchronous)  
Comment 3 print(Synchronous)  
Manual print(Synchronous)  
Date and time print(Synchronous)  
Comment 1 print(Asynchronous)  
Comment 2 print(Asynchronous)  
Comment 3 print(Asynchronous)  
Manual print(Asynchronous)  
Date and time print(Asynchronous)

● 7.2.10 Temperature Unit

Setting	Temp Unit
. . . . .	. .

Centigrade Unit  
Fahrenheit Unit

### 7.2.11 Point Calibration

Setting	Function	
. . . .	. . . . . . . . . . . . . . . . .	Zero point calibration Span point calibration Hysteresis at left/right move Ribbon select calibration

### ● 7.2.12 Data Calibration

Setting	Function	
. . . .	. . . . . . . . . . . .	Voltage calibration Resistance temperature detector calibration Internal reference junction compensation calibration

### ● 7.3 Terminating the Engineering Mode

Setting	Function	
. . .	. . . . . . . . . .	Save a set value Cancel a set value

#### [Note]

Upon termination if you select ". . ." and turn off the power without executing ". . . . .", the setting will become invalid. For ". . ." operation, see Page 84.

**Table 7.3 Initial setting value of the engineering mode**

Setting items	Initial set	Remarks
★Alarm hysteresis	ON(0.5%)	
★Burnout (all channels)	OFF	
★Channel offset (all channels)	0.0	
★RJC (all channels)	Internal compensation INT	
★Dot print color (1~6channel)	Purple(1), Red(2), Green(3), Blue(4), Brown(5), Black(6)	
★RUN record RUN/STOP trigger Channel/Tag print Alarm print Logging print Logging printing interval Logging print reference time Scale print Logging print Sync/Async Record Start/End print	INT Ch OFF ON 6H 00:00 OFF Sync print OFF	Use the RUN key
★COM (communication) Protocol Address Baud rate Data length Parity bit Stop bit	Original 01 9600 8bit None 1bit	
★DI (1~3 channel)	OFF	
★Temperature unit	Centigrade Unit	



### 7.2.1 Alarm Hysteresis

Setting 0.5 % hysteresis to the values at alarm activation and alarm recovery is possible. (Common to all the alarms)

Example) When turning off alarm hysteresis.

Display	Operation keys	Description
<input type="checkbox"/> . . . . .	ENT △ PRINT ENT	Enter the engineering mode (See the key operation in page 69). Use the △ key to display ". . . . .", and press the "ENT" key.
<input type="checkbox"/> . . .	△ PRINT ENT	Use the △ key to display ". . .", and press the "ENT" key.

### 7.2.2 Burnout ON/OFF

Setting Burnout High (to deflect the recording over the span) for each channel is possible.

Example) When setting Burnout High for Channel 4.

Display	Operation keys	Description
<input type="checkbox"/> . . . .	ENT △ PRINT ENT	Enter the engineering mode (See the key operation in page 69). Use the △ key to display ". . . .", and press the "ENT" key.
<input type="checkbox"/> . . .	△ PRINT ENT	Use the △ key to display ". . .", and press the "ENT" key.
<input type="checkbox"/> . .	△ PRINT ENT	Use the △ key to select ". .", and press the "ENT" key.

### 7.2.3 Channel Offset

For channel offset setting, set the value to be added to an actual process variable.

Example) When setting the value (3.0) to be added to Channel 3.

Display	Operation keys	Description
<input type="checkbox"/> . . . . .	ENT △ PRINT ENT	Enter the engineering mode (See the key operation in page 69). Use the △ key to display ". . . . .", and press the "ENT" key.
<input type="checkbox"/> . . .	△ PRINT ENT	Use the △ key to select ". . .", and press the "ENT" key.
<input type="checkbox"/> . . . . .	△ PRINT FEED ENT	Use the △ key to alter a sign/numerical value or shift a decimal point. Use the . key to shift a digit. Once the numerical value is decided, press the "ENT" key.

## 7.2.4 Reference Junction Compensation

The following describes how to set the method for compensating an electromotive force generated between a thermocouple wire or compensation lead wire and a terminal. There are the following three compensating methods:

- A method to compensate through the built-in temperature sensing element (INT: Internal compensation)
- A method to compensate by keeping an external compensator's temperature constant (EXT: External compensation)
- A method to compensate by one input for the recorder temperature which gets external junction box. (CH: Channel input compensation)

Internal compensation (INT) has been initially set.

Example) When setting the external compensator's temperature constant voltage for Channel 6 to  $391 \mu\text{V}$ . Input the thermocouple T, compensate the external compensator's temperature  $10^\circ\text{C}$  and Input the electromotive force  $391 \mu\text{V}$ .

Display	Operation keys	Description
<div style="display: flex; align-items: center;"> <div style="border: 1px solid black; width: 30px; height: 30px; margin-right: 10px;"></div> <div style="border: 1px solid black; padding: 5px; display: flex; align-items: center; justify-content: center;"> <span style="font-size: 24px;">. . .</span> </div> </div>	<div style="display: flex; flex-direction: column; align-items: center;"> <div style="border: 1px solid black; padding: 2px 10px; margin-bottom: 5px;">ENT</div> <div style="margin-bottom: 5px;">△</div> <div style="display: flex; gap: 10px;"> <div style="border: 1px solid black; padding: 2px 10px;">PRINT</div> <div style="border: 1px solid black; padding: 2px 10px;">ENT</div> </div> </div>	<p>Enter the engineering mode (See the key operation in page 69). Use the <math>\Delta</math> key to display ". . .", and press the "ENT" key</p>
<div style="display: flex; align-items: center;"> <div style="border: 1px solid black; width: 30px; height: 30px; margin-right: 10px;"></div> <div style="border: 1px solid black; padding: 5px; display: flex; align-items: center; justify-content: center;"> <span style="font-size: 24px;">. . .</span> </div> </div>	<div style="display: flex; flex-direction: column; align-items: center;"> <div style="margin-bottom: 5px;">△</div> <div style="display: flex; gap: 10px;"> <div style="border: 1px solid black; padding: 2px 10px;">PRINT</div> <div style="border: 1px solid black; padding: 2px 10px;">ENT</div> </div> </div>	<p>Use the <math>\Delta</math> key to select ". . .", and press the "ENT" key.</p>
<div style="display: flex; align-items: center;"> <div style="border: 1px solid black; width: 30px; height: 30px; margin-right: 10px;"></div> <div style="border: 1px solid black; padding: 5px; display: flex; align-items: center; justify-content: center;"> <span style="font-size: 24px;">. . .</span> </div> </div>	<div style="display: flex; flex-direction: column; align-items: center;"> <div style="margin-bottom: 5px;">△</div> <div style="display: flex; gap: 10px;"> <div style="border: 1px solid black; padding: 2px 10px;">PRINT</div> <div style="border: 1px solid black; padding: 2px 10px;">ENT</div> </div> </div>	<p>Use the <math>\Delta</math> key to select ". . .", and press the "ENT" key.</p>
<div style="display: flex; align-items: center;"> <div style="border: 1px solid black; width: 30px; height: 30px; margin-right: 10px;"></div> <div style="border: 1px solid black; padding: 5px; display: flex; align-items: center; justify-content: center;"> <span style="font-size: 24px;">. . . . .</span> </div> </div>	<div style="display: flex; flex-direction: column; align-items: center;"> <div style="margin-bottom: 5px;">△</div> <div style="display: flex; gap: 10px;"> <div style="border: 1px solid black; padding: 2px 10px;">PRINT</div> <div style="border: 1px solid black; padding: 2px 10px;">FEED</div> </div> <div style="margin-top: 10px; border: 1px solid black; padding: 2px 10px;">ENT</div> </div>	<p>Use the <math>\Delta</math> key to alter a numerical value, or the <math>\cdot</math> key to shift a digit. Once the numerical value is decided, press the "ENT" key.</p>
<div style="display: flex; align-items: center;"> <div style="border: 1px solid black; width: 30px; height: 30px; margin-right: 10px;"></div> <div style="border: 1px solid black; padding: 5px; display: flex; align-items: center; justify-content: center;"> <span style="font-size: 24px;">. . .</span> </div> </div>		<p>Setting is completed. Returned to the channel setting.</p>

Example) When Channel 1 input compensates Channel 6 reference junction.

	Display	Operation keys	Description
<input type="checkbox"/>	• • •	ENT	Enter the engineering mode (See the key operation in page 69). Use the $\Delta$ key to display "• • •", and press the "ENT" key.
<input type="checkbox"/>	• • •	$\Delta$ PRINT ENT	
<input type="checkbox"/>	• • •	$\Delta$ PRINT ENT	Use the $\Delta$ key to select "• • •", and press the "ENT" key.
<input type="checkbox"/>	• •	$\Delta$ PRINT ENT	Use the $\Delta$ key to select "• •", and press the "ENT" key.
<input type="checkbox"/>	• • •	$\Delta$ PRINT ENT	Use the $\Delta$ key to select "• • •", and press the "ENT" key.
<input type="checkbox"/>	• • •		Setting is completed. Returned to the channel setting.

### 7.2.5 Changing the Printing Color

Change a printing color can be changed for each channel.

Example) When setting the black color as a printing color.

	Display	Operation keys	Description
<input type="checkbox"/>	• • • • •	ENT	Enter the engineering mode (See the key operation in page 69). Use the $\Delta$ key to display "• • • • •", and press the "ENT" key.
<input type="checkbox"/>	• • •	$\Delta$ PRINT ENT	
<input type="checkbox"/>	• • •	$\Delta$ PRINT ENT	Use the $\Delta$ key to select "• • •", and press the "ENT" key.
<input type="checkbox"/>	• • •	$\Delta$ PRINT ENT	Use the $\Delta$ key to display "• • •", and press the "ENT" key.
<input type="checkbox"/>	• • • • •	$\Delta$ PRINT FEED ENT	Setting is completed. Returned to the Printing Color Setting screen.

## 7.2.6 Settings Related to Recording

Setting a recording start/stop trigger, select tag/channel print selection, alarm print, logging print, and scale print ON/OFF is possible.

### (1) Recording start/stop trigger setting

Set whether the trigger of recording start/stop should be by the "RUN" key or DI.

Example) When setting DI as the recording start/stop trigger.

Display	Operation keys	Description
<input type="checkbox"/> . . .	ENT △ PRINT ENT	Enter the engineering mode (See the key operation in page 69). Use the △ key to display ". . .", and press the "ENT" key.
<input type="checkbox"/> . . . . .	△ PRINT ENT	Use the △ key to select ". . . . .", and press the "ENT" key.
<input type="checkbox"/> . . .	△ PRINT ENT	Use the △ key to display ". . .", and press the "ENT" key.
<input type="checkbox"/> . . . . .	△ PRINT FEED ENT	Setting is completed. Returned to the Recording Start/Stop Setting screen.

#### [Note]

When displays ". . . . .", "RUN/STOP" key does not operate. Set ". . . ." to DI.  
See DI functions in page 80.

### (2) Tag/channel print selection

In case of logging print; or manual print, set whether a tag or channel should be printed.

Example) When setting the tag.

Display	Operation keys	Description
<input type="checkbox"/> . . .	ENT △ PRINT ENT	Enter the engineering mode (See the key operation in page 69). Use the △ key to display ". . .", and press the "ENT" key.
<input type="checkbox"/> . . .	△ PRINT ENT	Use the △ key to select ". . .", and press the "ENT" key.
<input type="checkbox"/> . . .	△ PRINT ENT	Use the △ key to display ". . .", and press the "ENT" key.
<input type="checkbox"/> . . .		Setting is completed. Returned to the Tag/Channel Setting screen.

**(3) Alarm print ON/OFF**

Setting the alarm print ON/OFF.

When ON1, prints the alarm occurring and the alarm recovering. When ON2, prints only the alarm occurring.

Example) When sets both the alarm occurring and the alarm recovering.

	Display	Operation keys	Description
<input type="checkbox"/>	. . .	ENT △ PRINT ENT	Enter to the engineering mode (See the key operation in page 69). Use the △ key to display “. . .”, and press the “ENT” key.
<input type="checkbox"/>	. . . . .	△ PRINT ENT	Use the △ key to select “. . . . .”, and press the “ENT” key.
<input type="checkbox"/>	. . .	△ PRINT ENT	Use the △ key to display “. . .”, and press the “ENT” key.
<input type="checkbox"/>	. . . . .		Setting is completed. Returned to the Alarm Print Setting screen.

**(4) Logging print ON/OFF**

Set logging print to ON/OFF.

In case of logging print ON, set the print start time and print interval.

Setting	ON/OFF	Printing Start time	Interval	Sync./ASync.
. . . . .	. . . . .	. . . . .	. .	. . . . . . . . . .















Example) When you want logging print to start at 18:00 every day.

Display	Operation keys	Description
□    . . .	ENT △ PRINT    ENT	Enter the engineering mode (See the key operation in page 69). Use the △ key to display ". . .", and press the "ENT" key.
□    . . . . .	△ PRINT    ENT	Use the △ key to select ". . . . .", and press the "ENT" key.
□    . .	△ PRINT    ENT	Use the △ key to display ". .", and press the "ENT" key.
□    . . . . . (Print Start Time)	△ PRINT    FEED ENT	Use the △ key to alter a numeral, and . key to shift a digit. Then, set the time and press the "ENT" key.
□    . . . (Interval)	△ PRINT    ENT	Use the △ key to display ". . .", and press the "ENT" key.
□    . . . . . (Sync./ASync.)	△ PRINT    ENT	Use the △ key to display ". . . . .", and press the "ENT" key.
□    . . . . .		Setting is completed. Returned to the Logging print Setting screen.

### **(5) Scale print ON/OFF**

Set scale print to ON/OFF.















Example) When setting scale prints to OFF.

Display	Operation keys	Description
 <span style="border: 1px solid black; padding: 2px 10px;">. . .</span>	   	Enter the engineering mode (See the key operation in page 69). Use the $\Delta$ key to display ". . .", and press the "ENT" key.
 <span style="border: 1px solid black; padding: 2px 10px;">. . . . .</span>	  	Use the $\Delta$ key to select ". . . . .", and press the "ENT" key.
 <span style="border: 1px solid black; padding: 2px 10px;">. . .</span>	  	Use the $\Delta$ key to display ". . .", and press the "ENT" key.
 <span style="border: 1px solid black; padding: 2px 10px;">. . . . .</span>		Setting is completed. Returned to the Scale Print Setting screen.

### **(6) Record Start/End Print OFF/SYNC/ASYNC**

Set Start/End print to OFF/Synchronous print/Asynchronous print.

Example) When setting Start/End print to asynchronous print.

Display	Operation keys	Description
 <span style="border: 1px solid black; padding: 2px 10px;">. . .</span>	   	Enter the engineering mode (See the key operation in page 69). Use the $\Delta$ key to display ". . .", and press the "ENT" key.
 <span style="border: 1px solid black; padding: 2px 10px;">. . . . .</span>	  	Use the $\Delta$ key to select ". . . . .", and press the "ENT" key.
 <span style="border: 1px solid black; padding: 2px 10px;">. . . . .</span>	  	Use the $\Delta$ key to display ". . . . .", and press the "ENT" key.
 <span style="border: 1px solid black; padding: 2px 10px;">. . . . .</span>		Setting is completed. Returned to the Record Start/End print Setting screen.

### 7.2.7 Setting the Communication Function

Set Local Address, Baud Rate (communication speed), Data Length, Parity Bit, and Stop Bit.

Example) Local Address: 02, Baud Rate: 1200bps, Data Length: 7 bit, Parity Bit: even, Stop Bit: 2 bit.

Display	Operation keys	Description
<input type="checkbox"/> . . .	<input type="button" value="ENT"/> <input type="button" value="PRINT"/> <input type="button" value="ENT"/>	Enter the engineering mode (See the key operation in page 69). Use the $\Delta$ key to display ". . .", and press the "ENT" key.
<input type="checkbox"/> . . . . . (Protocol)	<input type="button" value="PRINT"/> <input type="button" value="ENT"/>	Use the $\Delta$ key to display ". . . . .", and press the "ENT" key. (Select from ". . . . . (Original)", ". . . . . (Modbus-RTU)")
<input type="checkbox"/> . . . . . (Local address)	<input type="button" value="PRINT"/> <input type="button" value="ENT"/>	Use the $\Delta$ key to display ". . . . .", and press the "ENT" key. (Select from . . . . . ~ . . . . .)
<input type="checkbox"/> . . . . . (Baud rate)	<input type="button" value="PRINT"/> <input type="button" value="ENT"/>	Use the $\Delta$ key to display ". . . . .", and press the "ENT" key. (Select from 1200, 2400, 4800, 9600, 19200, 38400)
<input type="checkbox"/> . . . . . (Data length)	<input type="button" value="PRINT"/> <input type="button" value="ENT"/>	Use the $\Delta$ key to display ". . . . .", and press the "ENT" key. (Select from 7 bit, 8 bit)
<input type="checkbox"/> . . . . . (Parity bit)	<input type="button" value="PRINT"/> <input type="button" value="ENT"/>	Use the $\Delta$ key to display ". . . . .", and press the "ENT" key. (Select from EVEN, ODD and NONE)
<input type="checkbox"/> . . . . . (Stop bit)	<input type="button" value="PRINT"/> <input type="button" value="ENT"/>	Use the $\Delta$ key to display ". . . . .", and press the "ENT" key. (Select from 1 bit, 2 bit)
<input type="checkbox"/> . . .		Setting is completed. Returned to the Communication Function Setting screen.

### 7.2.8 Initializing the Setup Data and Calibration Data

When you select the ". . .", the setup mode settings is all initialized.

When you select the ". . .", is reset to the factory default calibration value.

In addition, setup mode settings are not initialized. Operation Please consult with care.

Example) When you initialize the Setup Data.

Display	Operation keys	Description
<input type="checkbox"/> . . . . .	<input type="button" value="ENT"/> <input type="button" value="PRINT"/> <input type="button" value="ENT"/>	Enter the engineering mode (See the key operation in page 69). Use the $\Delta$ key to display ". . . . .", and press the "ENT" key.
<input type="checkbox"/> . . .	<input type="button" value="PRINT"/> <input type="button" value="ENT"/>	Use the $\Delta$ key to select ". . .", and press the "ENT" key.
<input type="checkbox"/> . . . . .		Initialization is completed.



## 7.2.9 DI Functions

Allocate the functions to three DIs. There are the following 12 DI functions.

No function	: . . . .
Manual print (Sync.)	: . . . . . (Positive edge: running start)
Manual Print (Async.)	: . . . . . (Positive edge: running start)
RUN/STOP trigger function	: . . . . (ON:RUN, OFF:STOP)
Date/Time Print (Sync.)	: . . . . . (Positive edge: running start)
Date/Time Print (Async.)	: . . . . . (Positive edge: running start)
Chart speed selection	: . . . . . (ON:Spd-1, OFF:Spd-2)
Comment print 1-3 (Sync.)	: . . . . . , . . . . . , . . . . . (Positive edge: running start)
Comment print 1-3 (Async.)	: . . . . . , . . . . . , . . . . . (Positive edge: running start)

Example) When setting comment prints 3 for DI3.

Display	Operation keys	Description
<input type="checkbox"/> . .	<input type="button" value="ENT"/>	Enter the engineering mode (See the key operation in page 69). Use the $\Delta$ key to display ". .", and press the "ENT" key.
<input type="checkbox"/> . . .	<input type="button" value="PRINT"/> <input type="button" value="ENT"/>	
<input type="checkbox"/> . . . .	<input type="button" value="PRINT"/> <input type="button" value="ENT"/>	Use the $\Delta$ key to select ". . . .", and press the "ENT" key.
<input type="checkbox"/> . . . . .	<input type="button" value="PRINT"/> <input type="button" value="ENT"/>	Use the $\Delta$ key to display ". . . . .", and press the "ENT" key.
<input type="checkbox"/> . . .		Setting is completed. Returned to the DI3 Function Setting screen.

### [Note]

The setting is OFF without the DI option. Do not set any setting except for OFF.

## 7.2.10 Temperature Unit

It changes the setting of a temperature unit.

Example) When setting a temperature unit to being Fahrenheit.

Display	Operation keys	Description
<input type="checkbox"/> . . . . .	<input type="button" value="ENT"/>	Enter the engineering mode (See the key operation in page 69). Use the $\Delta$ key to indicate ". . . . .", and press the "ENT" key.
<input type="checkbox"/> .	<input type="button" value="PRINT"/> <input type="button" value="ENT"/>	
<input type="checkbox"/> . . . . .	<input type="button" value="PRINT"/> <input type="button" value="ENT"/>	Setting is completed. Returned to the Temperature Unit Setting screen.

### [Note]

When changes temperature unit, all set up data (configuration) becomes initial.

### 7.2.11 Point Calibration

Calibrate a dot printing position.

- • • • : Calibration of the zero point position
- • • • • : Calibration of the span point position

**[Note]**  
 Point calibration "• • • •" and "• • • • •" are setup item before shipment. Do not change the setup value.

Example) When calibrating the zero point.

Display	Operation keys	Description
<input type="checkbox"/> • • • •	ENT △ PRINT ENT	Enter the engineering mode (See the key operation in page 69). Use the △ key to display "• • • •", and press the "ENT" key.
<input type="checkbox"/> • • • •	△ PRINT ENT	Use the △ key to select "• • • •", and press the "ENT" key.
<input type="checkbox"/> • • • • •	△ PRINT FEED	The instrument starts to feed and print the chart paper. With the △ (left move) and • (right move), adjust the 0 mm position of the chart paper and the recording position. Press the "ENT" key. Display displays the set counter value.
<input type="checkbox"/> • • • •	ENT	Setting is completed. Returned to the Zero Point Calibration screen.

Example) When calibrating the span point.

Display	Operation keys	Description
<input type="checkbox"/> • • • •	ENT △ PRINT ENT	Enter the engineering mode (See the key operation in page 69). Use the △ key to display "• • • •", and press the "ENT" key.
<input type="checkbox"/> • • • •	△ PRINT ENT	Use the △ key to select "• • • •", and press the "ENT" key.
<input type="checkbox"/> • • • • •	△ PRINT FEED	The instrument starts to feed and print the chart paper. With the △ (left move) and • (right move), adjust the 100 mm position of the chart paper and the recording position. Press the "ENT" key. Display displays the set counter value.
<input type="checkbox"/> • • • •	ENT	Setting is completed. Returned to the Span Point Calibration screen.

## 7.2.12 Data Calibration

Calibrate the voltage, resistance temperature detector, and reference junction compensation.

- • • • : Calibration of the voltage
- • • : Calibration of the resistance temperature detector
- • • : Calibration of reference junction compensation

### [Note]

This recorder is precisely proofread. First of all, please reconfirm a setting value when the instruction value is abnormal.

The calibration value abnormality doesn't usually occur.

Example) When calibrating the voltage at Channel 1.

	Display	Operation keys	Description
	• • • •	ENT	Enter the engineering mode (See the key operation in page 69). Use the $\Delta$ key to display "• • • •", and press the "ENT" key. Use the $\Delta$ key to select "• • • •", and press the "ENT" key. Select the channel where an instrument for calibration such as a mV generator is connected, and then, press the "ENT" key.
	• • • •	$\Delta$ PRINT ENT	
	• • •	$\Delta$ PRINT ENT	Enter 0 mV. After 30 seconds, make sure that the ALM lamp unilluminates and press the "ENT" key. Enter 15 mV. After 10 seconds, make sure that the ALM lamp unilluminates and press the "ENT" key. Enter 25 mV. After 10 seconds, make sure that the ALM lamp unilluminates and press the "ENT" key. Enter 35 mV. After 10 seconds, make sure that the ALM lamp unilluminates and press the "ENT" key. Enter 55 mV. After 10 seconds, make sure that the ALM lamp unilluminates and press the "ENT" key. Enter 200 mV. After 10 seconds, make sure that the ALM lamp unilluminates and press the "ENT" key. Enter 1 V. After 10 seconds, make sure that the ALM lamp unilluminates and press the "ENT" key. Enter 5 V. After 10 seconds, make sure that the ALM lamp unilluminates and press the "ENT" key. Enter 10 V. After 10 seconds, make sure that the ALM lamp unilluminates and press the "ENT" key. If the calibration is correct, select "• • • • •" with the $\Delta$ key, and if incorrect, select "• • • • •", respectively. Then, press the "ENT" key.
•	• • • •	ENT	
•	• • • •	ENT	
•	• • • •	ENT	
•	• • • •	ENT	
•	• • • •	ENT	
•	• • • •	ENT	
•	• • • •	ENT	
•	• • • •	ENT	
•	• • • •	ENT	
•	• • • •	ENT	
•	• • • •	ENT	
	• • • • •	$\Delta$ PRINT ENT	

### [Note]

For calibration for voltage input, only one channel calibration is effective to all the channel.

Example) When calibrating the resistance temperature detector at Channel 2.

Display	Operation keys	Description
		Enter the engineering mode (See the key operation in page 69). Use the $\Delta$ key to display ". . . .", and press the "ENT" key. Use the $\Delta$ key to select ". . . .", and press the "ENT" key. Select the channel where the instrument for calibration such as a dial resistor is connected and then, press the "ENT" key.
		Enter 100 $\Omega$ . After 10 seconds, make sure that the ALM lamp unilluminates and press the "ENT" key.
		Enter 150 $\Omega$ . After 10 seconds, make sure that the ALM lamp unilluminates and press the "ENT" key.
		Enter 300 $\Omega$ . After 10 seconds, make sure that the ALM lamp unilluminates and press the "ENT" key.
		If the calibration is correct, select ". . . . ." with the $\Delta$ key, and if incorrect, select ". . . . .", respectively. Then, press the "ENT" key.

**[Note]**  
When calibrate RTD for a channel, the input terminals of the other channels are shortcut. Recording requires RTD calibration for every channel.

**[Note]**  
During calibration, ALM lamp displays following conditions below.

① Unilluminating the ALM lamp  
The calibration is within the range.

② Blinking the ALM lamp  
Judges the input value.

③ Illuminating the ALM lamp  
Make sure that the connection is properly or input is correctly.

displays unilluminating the lamp.

displays illuminating the lamp.

If the calibration value outside the input range was applied, . . . . . (voltage) or . . . . . (RTD) is displayed when you return to the measurement mode.

In that case, to calibration again or, please return to the state of the factory default calibration value by performing the " Initializing the Setup Data and Calibration Data " described in Section 7.2.8.

Example) When setting the terminal temperature for Channel 1.

Display	Operation keys	Description
		Enter the engineering mode (See the key operation in page 69). Use the $\Delta$ key to display ". . . .", and press the "ENT" key.
		Use the $\Delta$ key to select ". . .", and press the "ENT" key.
		Select the Channel to set, and press the "ENT" key. Measure and display the real time terminal temperature. When press the "ENT" key, turn to the setting temperature display.
		Use the $\Delta$ key to alter a numeral, and $\cdot$ key to shift a digit. Then, press the "ENT" key. See 9.5 (3) Calibration of Reference Junction Compensation. If the calibration is correct, select ". . . . ." with the $\Delta$ key, and if incorrect, select ". . . . .", respectively. Then, press the "ENT" key.

**[Note]**  
 When calibrate the terminal temperature, select a channel to calibrate for channel 1 to channel 3, and select another channel for channel 4 to channel 6. Calibrate these channels separately.

### 7.3 Terminating the Engineering Mode

Example) The following describes how to save the setting data.

Display	Operation keys	Description
		Use the $\Delta$ key to display ". . .", and press the "ENT" key.
		Use the $\Delta$ key to select ". . . . .", and press the "ENT" key. The settings of the engineering mode have been saved. Recording starts under the new settings.

**[Note]**  
 Upon termination, if you select ". . ." and turn off the power without selecting ". . . . .", the settings will become invalid. Selecting ". . . . ." invalidates the settings and starts recording under the previous settings.

## 8.1 General Description

### 8.1.1 General Description of Functions

This Recorder has the following communication functions:

- ① Outputting the process variable  
Process variable, alarms status, etc.
- ② Outputting the set value  
Reading the setup data such as a range, chart speed, etc.
- ③ Inputting the set value  
Writing the setup data such as a range, chart speed, etc.
- ④ Controlling of the recorder (Partially)  
Selection to print, recording start/stop and changing display etc.

For the functions ② to ④, see the separate Communication Command Reference Manual (charged). Setting the engineering mode is not capable with communication.

### 8.1.2 Transmission Specifications

- (1) Communication system :Start-stop synchronous, half-duplex communications
- (2) Connection :One-to-one(RS-232C), One-to-N(RS-485); N = 1 to 32
- (3) Communication speed :1200, 2400, 4800, 9600, 19200, or 38400 bps
- (4) Start bit :1 bit
- (5) Stop bit :1 or 2 bits
- (6) Parity :Even, Odd, or None
- (7) Data length :7 or 8 bits

## 8.2 Original Protocol

### 8.2.1 Data Construction

#### (1) Character construction

In order to send one data (byte) in start-stop synchronous communications, the following character construction is assumed:

Start Bit (1) + Data Bit (7 or 8) + Parity Bit (1) + Stop Bit (1 or 2)

#### (2) Data format

The communication data is sent with data terminators added to multiple characters. Upon receiving these terminators, the recorder starts analyzing the communication data.

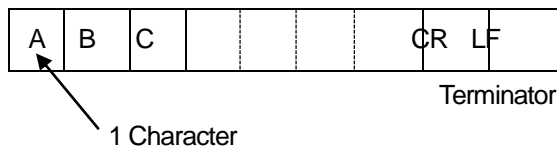

#### (3) Error Detection

If the recorder receives the data that has resulted in a signal error such as a parity error, framing error, etc. due to the noise or hardware troubles, it will ignore that data. Consequently, a data format error results, determining that the data is not sent in the normal data format. The receiving function does not execute that command and the transmitting function does not reply. The data format error status can be confirmed by the ESC S command (described later).

#### (4) Control codes

ESC: 1B HEX (hexadecimal)

This code is used for an escape sequence such as opening/closing the link.  
It cannot be treated as part of the text data.

CR: 0D HEX (hexadecimal)

This data is added to the end of the text data together with the LF data.  
This code cannot be treated as part of the text data.

LF: 0A HEX (hexadecimal)

This data is added to the end of the text data together with the CR data.  
This code cannot be treated as part of the text data.

### 8.2.2 Opening/Closing the Link

To communicate with the recorder, you must establish a connection between the host computer and the recorder. In case of one-to-N communications, it is necessary to inform each recorder which recorder the text is being sent. If a link open command is sent to multiple recorders through their send function, all the recorders, which have received the command, will send and cannot receive the normal data.

1) Open Command

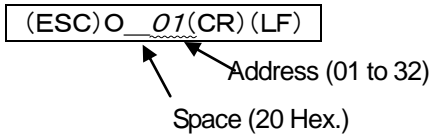

For the host computer to communicate the recorder, it must issue this command and memorize that it has been issued.

2) Close Command

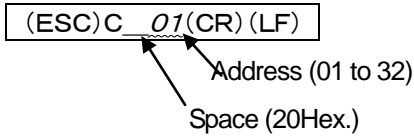

For the host computer to communicate with the recorder, this command must be issued to the open-link recorder, if you want to send the data to the recorders, which have not issued the open command.

### 8.2.3 Outputting the Process Variable Data

1) Specifying the Process Variable Data Output



Once this command is received, the recorder transfers the process variable data to the transmit buffer, when the (ESC) T command is received.

2) Updating the Data

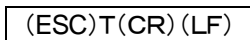

Once this command is received, the recorder transfers the update process variable data to the transmit buffer.

3) Specifying the Process Variable Data Output Order (At BINARY Mode Output)

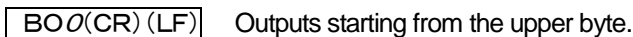

Outputs starting from the upper byte.

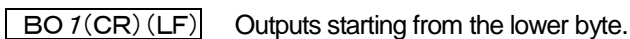

Outputs starting from the lower byte.

The recorder outputs starting from the lower byte, unless otherwise specified.

4) Outputting the Data



Specifies the ASCII mode output.



Specifies the BINARY mode output.

S\_CH :Output start channel 01 to 06

E\_CH :Output end channel 01 to 06

※ When the number of channels is one, specify (S\_CH) = (E\_CH).

Example) FM0,01,06(CR)(LF)..... ASCII,01 to 06 channel output.



## 5) Process Variable Data Transmission Format (ASCII)

DATE(YY)(MM)(DD)(CR)(LF) Date  
Year Month Day

TIME(HH)(MM)(SS)(CR)(LF) Time  
Hour Minute Second

(DS 1)(DS 2)(ALM 1)(ALM 2)(ALM 3)(ALM 4)(UNIT 1~6)(CHNo.), (DATA)(CR)(LF)

① DS 1 :Data information 1 (1 byte)

- N : Normal
- D : Difference computation data
- S : Sum computation data
- M : Average computation data
- R : Square root computation data
- C : Decade computation data
- O : Over range (Data =  $\pm 99999$ )
- S : Skip (All the data are spaces)

② DS 2 :Data information 2 (1 byte)

- E : Final data
- \_\_(Space) :Other data

③ ALM 1 to 4 :Alarm information (1 byte each, 4 bytes in total)

- H : Upper-limit alarm
- L : Lower-limit alarm
- \_\_(Space) : Alarm OFF or alarm setting OFF.

④ UNIT 1 to 6 :UNIT(6 bytes)

Returns the set unit in terms of code. (When sending the 7-bit data, the higher 1 bit is missing.)

⑤ CHNo. : Channel number (2 bytes)

01~06

⑥ DATA :Process variable data

- Sign(1 byte) : "+" or "-"
  - Data mantissa section (6 bytes) : 00000~99999
  - Data exponent section (4 bytes) : E (Sign: 1 byte) (Multiplier: 2 bytes)
- <Example> +99999E-02

6) Process Variable Data Transmission Format (BINARY)

Output bytes	Date and time	Process variable 1	Process variable 6
--------------	---------------	--------------------	--------------------

Output bytes (2 bytes) :5 × n (specified number of channels+6)

① Date and time (6 bytes):

①	②	③	④	⑤	⑥
---	---	---	---	---	---

- ① Year :00H to 63H (00H for the year 2000)
- ② Mouth :07H to 0CH
- ③ Day :07H to 7FH
- ④ Hour :00H to 17H (24-hour system)
- ⑤ Minute:00H to 3BH
- ⑥ Second:00H to 3BH

② Process variable (5 bytes):

CHNo.	A2	A1	A4	A3	DATA1	DATA2
-------	----	----	----	----	-------	-------

- CHNo.(1BYTE) :Channel number 07H~06H
- A1 to A4 (2BYTES) :Alarm type activated at each alarm level.
- 1 :Upper-limit alarm
- 2 :Lower-limit alarm
- 0 :Alarm OFF or alarm setting OFF

Example) Bit Sequence.

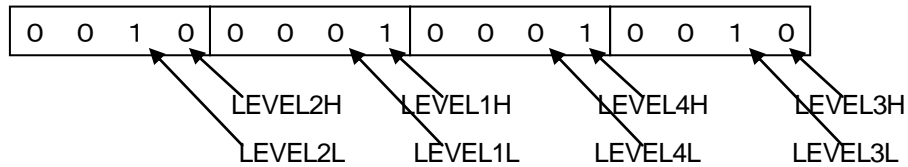

LEVEL × H :Upper-limit alarm bit at the alarm level x  
 LEVEL × L :Lower-limit alarm bit at the alarm level x

DATA1,DATA2 (2BYTES) : Process variable data  
 – 32000 to +32000 (2-byte hexadecimal data)  
 The higher and lower bytes can be reversed by the BO command.  
 If Skip is specified, 8080H will be output.

**[Note]**

- Outputs a data over -32000 to +32000 as the overflow. An overflow 7E7E is output on plus side, and 8181 is output on minus side. Excluding the Decade channel.
- It outputs data output by the Decade channel as follows regardless of the BO command. The upper byte outputs a mantissa (10 to 99). The lower byte outputs an exponent (-19 to 19). A decimal point position is fixed on 1 digit.

## 8.2.4 Outputting the Unit and Decimal Point Position Data

### 1) Specifying the Unit and Decimal Point Position Data Output

`TS2(CR)(LF)`

Once this command is received, the recorder transfers the unit and decimal point position data to the transmit buffer, when the (ESC) T command is received.

### 2) Updating the Data

`(ESC)T(CR)(LF)`

Once this command is received, the recorder transfers the update unit and decimal point position data to the transmit buffer.

### 3) Outputting the Data

`LF, S_CH, E_CH`

S\_CH :Output start channel 01 to 06

E\_CH :Output end channel 01 to 06

※ When the number of channels is one, specify (S\_CH) = (E\_CH).

Example) LF,01,06(CR)(LF)..... The unit and decimal point of 01 to 06 channel output.

### 4) Data Format

`(DS 1) (DS 2) (CHNo. ) (UNIT 1~ 6) (DP)`

- ① DS 1 :Data information 1 (1 byte)
  - N : Normal
  - D : Difference computation data
  - S : Sum computation data
  - M : Average computation data
  - R : Square root computation data
  - C : Decade computation data,
  - O : Over range (Data =  $\pm 99999$ )
  - S : Skip (All the data are spaces)
- ② DS 2 :Data information 2 (1 byte)
  - E :Final data,
  - \_(Space):Other data
- ③ CHNo. :Channel number (2bytes) ; 01~06
- ④ UNIT 1 to 6:UNIT
  - Returns the set unit in terms of code. (When sending the 7-bit data, the higher 1 bit is missing.)
- ⑤ DP :Decimal point information (1 byte) ; 0~4

#### [Note]

By the range setting, a decimal point position may differ from a display screen.

## 8.2.5 Outputting the Status

If the open-link recorder has a data error on its link, it will save the error as a communication error in the internal status area. The (ESC S) command reads this status. Issuing this command clears the on-going error.

### 1) Status Output Command

```
ESC S(CR)(LF)
```

Receiving this command outputs the status for the command received so far.

### 2) Status Output

```
E R X X CR LF
```

XX : 00~19

**Table 8.1 Status output list**

Status output	Status factor		
	A/D END	Syntax error	Paper empty
ER 00 C <sub>R</sub> L <sub>F</sub>			
ER 01 C <sub>R</sub> L <sub>F</sub>	○		
ER 02 C <sub>R</sub> L <sub>F</sub>		○	
ER 03 C <sub>R</sub> L <sub>F</sub>	○	○	
ER 04 C <sub>R</sub> L <sub>F</sub>			
ER 05 C <sub>R</sub> L <sub>F</sub>	○		
ER 16 C <sub>R</sub> L <sub>F</sub>			○
ER 17 C <sub>R</sub> L <sub>F</sub>	○		○
ER 18 C <sub>R</sub> L <sub>F</sub>		○	○
ER 19 C <sub>R</sub> L <sub>F</sub>	○	○	○

○ : The factor from which status is ENABLE.

A/D END : When carrying out AD conversion end, it occurs.

Syntax error : It occurs during a communication error or a command error occurs.

Paper-empty : When Paper-empty is found, it occurs.

(The Paper-empty option has been attached)

## 8.2.6 Data Reception Example

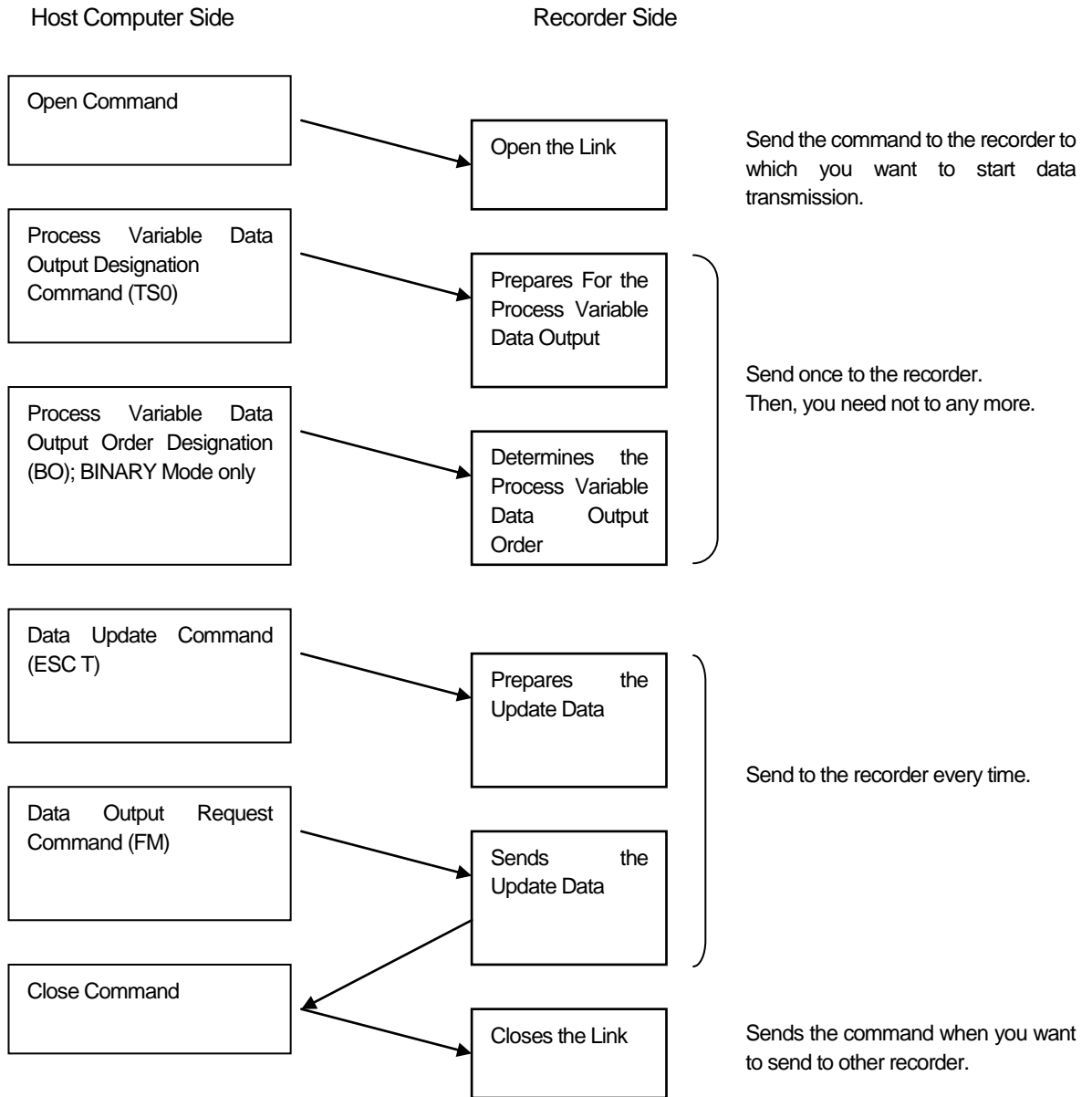

## 8.3 Modbus RTU Protocol

The Modbus protocol is a communication protocol developed for PLCs by Modicon Inc. (AEG Schneider Automation International S.A.S). It is described in the protocol specification (PI-MBUS-300 Rev. J). Refer to this document for information on the Modbus protocol specification.

### 8.3.1 Data Construction

Slave address (1 byte)	Function code (1 byte)	Data (variable)	CRC (2 bytes)
---------------------------	---------------------------	--------------------	------------------

### 8.3.2 Function Codes

The following function codes are available on this product:

Code	Function	Maximum data length	Modbus-specific function (reference)
03H	Setting data read	123 words	Data read from holding register
04H	Input data read	123 words	Data read from input register
06H	One-time data write	1 word	Data write to holding register
10H	Continuous data writes	123 words	Data write to holding register

### 8.3.3 Error Response

In accordance with the communication protocol for the pertinent function code, if an error occurs during command transmission, an error response is returned in the fixed format described in this section.

■ Example of slave response (function code = 06H, command error = 10H)

Component	Data length	Data
Slave address (only for Modbus RTU)	1	-
Function code + <b>80H</b>	1	86H
Error code	1	10H
Error check (only for Modbus RTU)	2	CRC
Total number of bytes	5	-

■ Error codes and their occurrence conditions

Error code	Description	Occurrence condition(s)
01H	Invalid function code	An unsupported function code is specified.
02H	Invalid register address	The relative address range exceeds "9999."
03H	Invalid number of registers	<ul style="list-style-type: none"> <li>- The length of the accessed data is "0" or the sum of the relative address and data length exceeds the limit.</li> <li>- It is assumed that two or more function codes, each executable for one area, are involved.</li> <li>- Data longer than 2 words is specified for a one-time write command.</li> <li>- The data length exceeds 123 words.</li> </ul>
04H	Device error	The received data is shorter than the predefined data length.
10H	Command error	An attempt at a write over an area exceeding the writable range.

### 8.3.4 Reading from the Input Register Area

The input register area is a read-only area. The current measured value and the current time are mapped. Specify the start address (relative) and data count (assuming that one word is two bytes) of the data to be read.

Function code: 04H

- Example of master transmission (with a start address of 0032H and a data count of 2 words)

Component		Data length	Data
Slave address		1	—
Function code		1	04H
Data	Relative start address (high-order)	1	00H
	Relative start address (low-order)	1	32H
	Read data count (high-order)	1	00H
	Read data count (low-order)	1	02H
Error check		2	CRC (16 bits)
Total number of bytes		8	

- Example of slave response (with a start address of 0032H and a data count of 2)

Component		Data length	Data
Slave address		1	—
Function code		1	04H
Data	Number of data bytes	1	04H
	Data 1 (high-order)	1	00H
	Data 1 (low-order)	1	09H
	Data 2 (high-order)	1	00H
	Data 2 (low-order)	1	0AH
Error check		2	CRC (16 bits)
Total number of bytes		9	

【Input Register Area Map】 Function code: 04H

Address	Relative address (HEX)	Name	Arrangement	Description	Remarks
30001	0	Model type (1/8)	1	ASCII	Multipoint type : "MULTI" Pen type : "PEN" After the blank
30002	1	Model type (2/8)	2		
30003	2	Model type (3/8)	3		
30004	3	Model type (4/8)	4		
30005	4	Model type (5/8)	5		
30006	5	Model type (6/8)	6		
30007	6	Model type (7/8)	7		
30008	7	Model type (8/8)	8		
30009	8	Software version (1/16)	1	ASCII	Version information on a system.
30010	9	Software version (2/16)	2		
30011	A	Software version (3/16)	3		
30012	B	Software version (4/16)	4		
30013	C	Software version (5/16)	5		
30014	D	Software version (6/16)	6		
30015	E	Software version (7/16)	7		
30016	F	Software version (8/16)	8		
30017	10	Software version (9/16)	9		
30018	11	Software version (10/16)	10		
30019	12	Software version (11/16)	11		
30020	13	Software version (12/16)	12		
30021	14	Software version (13/16)	13		
30022	15	Software version (14/16)	14		
30023	16	Software version (15/16)	15		
30024	17	Software version (16/16)	16		
30025	18	Modbus map version	1	Binary	
30026	19	Reserve	1		
30027	1A	Reserve	2		
30028	1B	Reserve	3		
30029	1C	Reserve	4		
30030	1D	Reserve	5		
30031	1E	Reserve	6		
30032	1F	Reserve	7		
30033	20	Reserve	8		
30034	21	Reserve	9		
30035	22	Reserve	10		
30036	23	Reserve	1		
30037	24	Reserve	2		
30038	25	Reserve	3		
30039	26	Reserve			
30040	27	Reserve			
30041	28	Reserve			
30042	29	Reserve			
30043	2A	Reserve			
30044	2B	Reserve			
30045	2C	Reserve			
30046	2D	Reserve			
30047	2E	Reserve			
30048	2F	Reserve			
30049	30	Reserve			



Address	Relative address (HEX)	Name	Arrangement	Description	Remarks
30050	31	Reserve			
30051	32	Year		0~99	Every second update
30052	33	Month		1~12	
30053	34	Day		1~31	
30054	35	Hour		0~24	
30055	36	Minute		0~59	
30056	37	Second		0~59	
30057	38	Recording status		0~1	0: Recording not in progress 1: Recording in progress
30058	39	Chart sensor status		0~1	0: With chart 1: Without chart
30059	3A	Manual print status		0~1	0: Print stops 1: During printing
30060	3B	List print status		0~1	0: Print stops 1: During printing
30061	3C	Engineering list print status		0~1	0: Print stops 1: During printing
30062	3D	Reserve			
30100	63	Reserve			
30101	64	Channel status	CH01	00bit: Alarm 1 1= ON 0= OFF 01bit: Alarm 2 1= ON 0= OFF 02bit: Alarm 3 1= ON 0= OFF 03bit: Alarm 4 1= ON 0= OFF	
30102	65		CH02		
30103	66		CH03		
30104	67		CH04		
30105	68		CH05		
30106	69		CH06		
30107	6A	Measurement data (BIN)	CH01	-32000~32000	Data of more than $\pm 32000$ , the minus side will be 8181H, the plus side will be 7E7EH.
30108	6B		CH02		
30109	6C		CH03		
30110	6D		CH04		
30111	6E		CH05		
30112	6F		CH06		
30113	70	Decimal point	CH01	0~4	
30114	71		CH02		
30115	72		CH03		
30116	73		CH04		
30117	74		CH05		
30118	75		CH06		
30119	76	Measurement data (Float)	CH01	Float (high-order 2 byte) Float (low-order 2 byte)	
30120	77				
30121	78		CH02		
30122	79				
30123	7A		CH03		
30124	7B				
30125	7C		CH04		
30126	7D				
30127	7E		CH05		
30128	7F				
30129	80		CH06		
30130	81				

Address	Relative address (HEX)	Name	Arrangement	Description	Remarks
30131	82	Unit (1/4)	CH01		Current unit
30132	83	Unit (2/4)			
30133	84	Unit (3/4)			
30134	85	Unit (4/4)			
30135	86	Unit (1/4)	CH02		Current unit
30136	87	Unit (2/4)			
30137	88	Unit (3/4)			
30138	89	Unit (4/4)			
30139	8A	Unit (1/4)	CH03		Current unit
30140	8B	Unit (2/4)			
30141	8C	Unit (3/4)			
30142	8D	Unit (4/4)			
30143	8E	Unit (1/4)	CH04		Current unit
30144	8F	Unit (2/4)			
30145	90	Unit (3/4)			
30146	91	Unit (4/4)			
30147	92	Unit (1/4)	CH05		Current unit
30148	93	Unit (2/4)			
30149	94	Unit (3/4)			
30150	95	Unit (4/4)			
30151	96	Unit (1/4)	CH06		Current unit
30152	97	Unit (2/4)			
30153	98	Unit (3/4)			
30154	99	Unit (4/4)			
30155	9A	Reserve			
...	...				

### 8.3.5 Reading from or Writing to the Holding Register Area

The holding register area is a read-write area. Parameter settings and the start and stop command of the recording state are mapped. For read, specify the start address (relative) and data count (assuming that one word is two bytes) of the data to be read. For write, specify the start address and the data to be written.

For Detail, see the separate "CR06 HYBRID RECORDER COMMUNICATION COMMAND INSTRUCTION MANUAL (HXPCR06mnC0005E)".

## 9. MAINTENANCE

Inspect the following maintenance items in order to use this instrument effectively.

- Inspection
- Cleaning
- Replace Consumables
- Adjust Dot Printing Position
- Calibration

### 9.1 Inspection

Inspect the condition of operation to use effectively.

When a defect is found, see Chapter 10 "Trouble Shooting".

- ◆ Trend recording deflected?
- ◆ Are recording indication done properly?
  - Any big error in indicated values or dot printing position?
  - Any improper dot printing?
  - Any blurred dot printing or printout?
  - Proper printout?
- ◆ Is the chart paper feed properly?
  - Is the chart paper folded properly?
  - Aren't the feed holes in the chart paper torn off or broken?
  - Is the chart speed correct?
- ◆ Is there any abnormal sound?

### 9.2 Cleaning

Many parts of this instrument are plastic. Use a dry cloth to wipe the parts should be clean.

**[Note]**

Do not use any organic solvent.

### 9.3 Replacing Consumables

In order to use this instrument effectively, replace the consumable parts as shown the following table.

No.	Name	Type	Period	Remarks	Quantity
1	Chart paper	HZCGA0105EL001	33 days	Chart speed is 20mm/h	1
2	Ribbon cassette	WPSR188A000001A	3months	Chart speed is 20mm/h	1

#### [Note]

- ① When recording with a ribbon, a dot printing color phases out. To ensure clear recording, replace the ribbon cassette as possible.
- ② Use the ribbon cassette within one year after its purchase. Due to evaporation of ink, a printing color phases out as time goes on.

### 9.4 Adjust Dot Printing Position (Point Calibration)

The following describes how to adjust a printing position on the chart paper.

You are well advised to adjust it annually in order to maintain recording accuracy.

#### How to Adjust

It is unnecessary to enter the reference. With the apparatus left in the working conditions, make adjustment according to the instructions in 7.2.11 Point Calibration.(See page 81)

### 9.5 Calibration (Data Calibration)

Calibrate a process variable input every year in order to keep measurement accuracy.

#### [Note]

Prior to calibration, warm up for 30 minutes or more after power-on.

#### Devices required for calibration

- Precision voltage(current) generator (Jointly use a digital voltmeter with accuracy of  $\pm 0.02\%$  or less as required)
- Precision dial resistor

### **(1) Calibration of Voltage**

Conduct calibration in case of voltage, current or thermocouple input. For thermocouple input, calibrate reference junction compensation together.

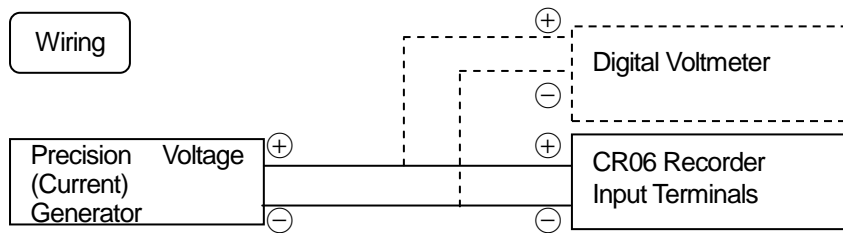

Conduct calibration according to the instructions in 7.2.12 Data Calibration (Calibration of the voltage).(See page 82)

#### **[Note]**

- ① Calibrate at any one channel.
- ② When a shunt resistor is attached to the input terminal block in case of current input, detach it prior to calibration.

### **(2) Calibration of Resistance temperature detector**

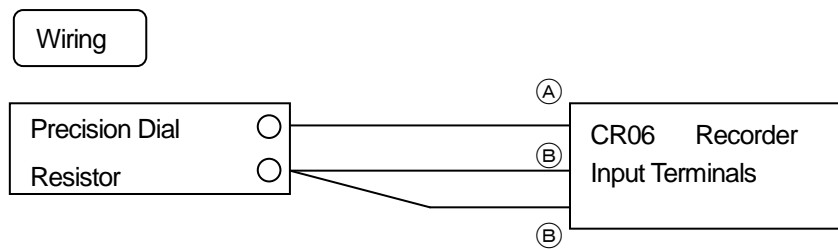

Conduct calibration according to the instructions in 7.2.12 Data Calibration (Calibration of the resistance temperature detector).(See page 83)

#### **[Note]**

A resistance value should not disperse greater than 6 m $\Omega$  from one wire to another.  
When calibrate RTD for a channel, the input terminals of the other channels are shortcut.  
Recording requires RTD calibration for every channel

### **(3) Calibration of Reference Junction Compensation**

Conduct this calibration in case of thermocouple input.

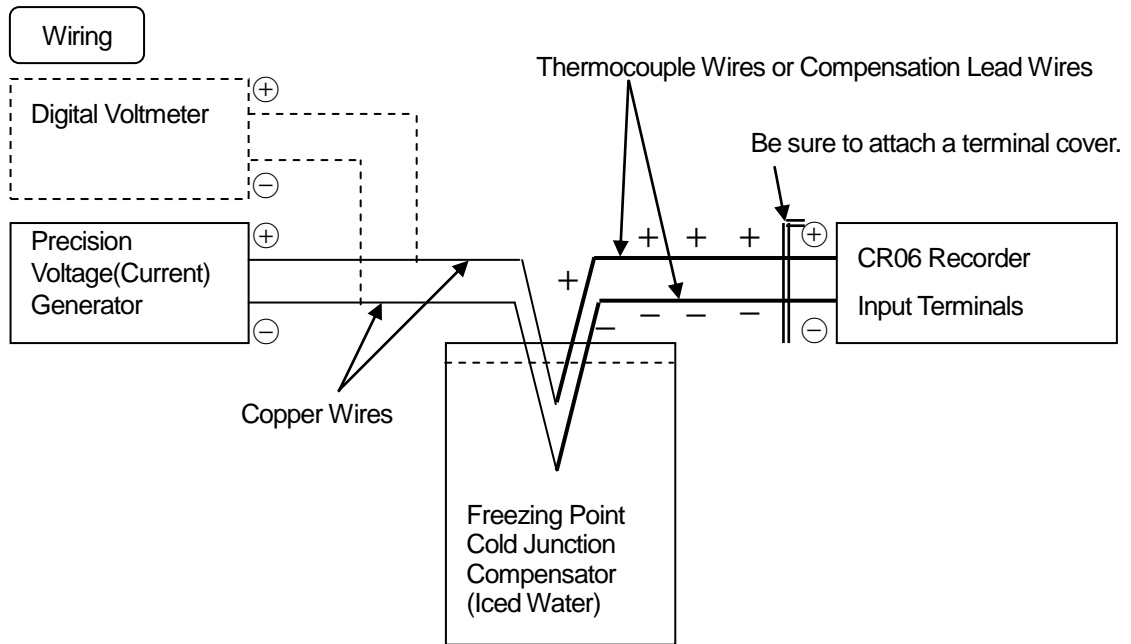

Example) Connect the input to Channel 1 and setting the calibration when the thermocouple input value (CR06 measurement) is -0.5 (input 0°C), the measured RJC temperature is 24.5°C.

- 5) Check the Process variable when impressing 0.000mV±2 μV to Channel 1 by the voltage generator beforehand. (In this example, it is -0.5°C.)
- 6) Check the terminal temperature of Channel 1 at the data calibration in the engineering mode (Reference junction compensation). (In this example, it is 24.5°C.)
- 7) Setup the value which added a part for the difference with true value (0.5°C) as the right RJC temperature.

$$[24.5 - (-0.5) = 25.0^{\circ}\text{C}]$$

Conduct calibration according to the instructions in 7.2.12 Data Calibration (Calibration of reference junction compensation). (See page 84)

#### **[Note]**

- ① This calibration is conducted when compensation by the recorder's built-in temperature sensing element (INT: internal compensation) is selected as the reference junction compensation method.
- ② Wire to Channels 1 and 4 to conduct calibration.
- ③ After wiring, attach the terminal covers and wait for 5 minutes or more. Then, conduct calibration.

# 10. TROUBLESHOOTING

## 10.1 Troubleshooting

### 10.1.1 Trouble Items

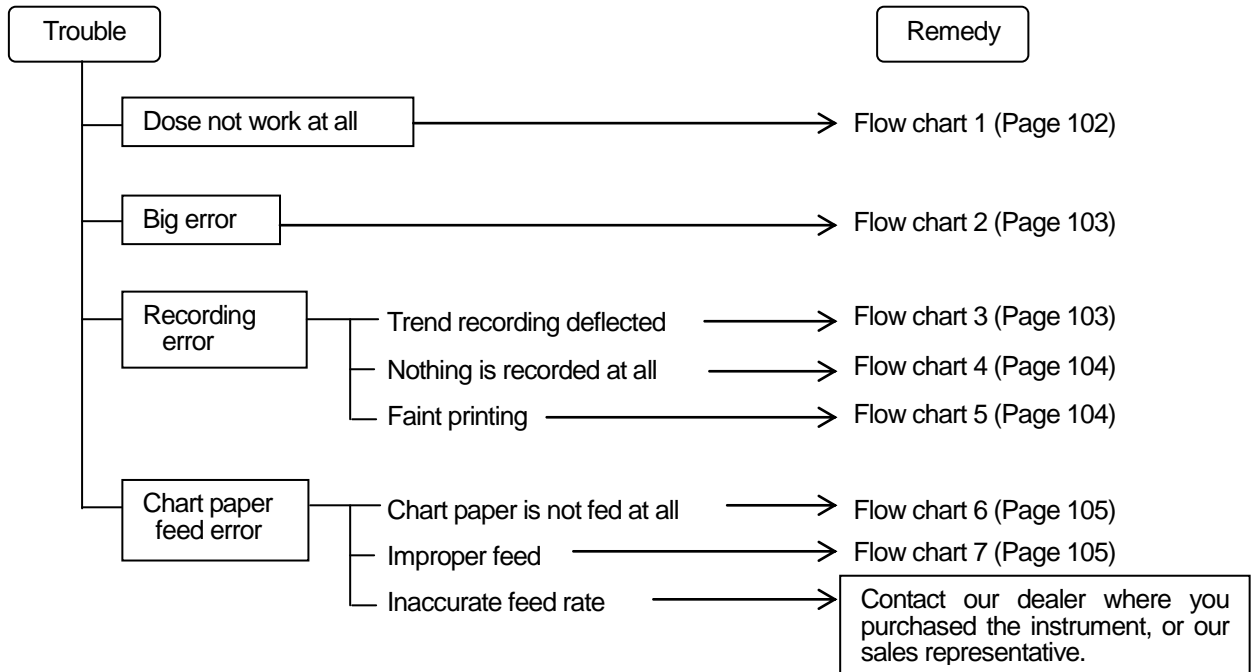

### 10.1.2 When the Recorder Dose not Work at All

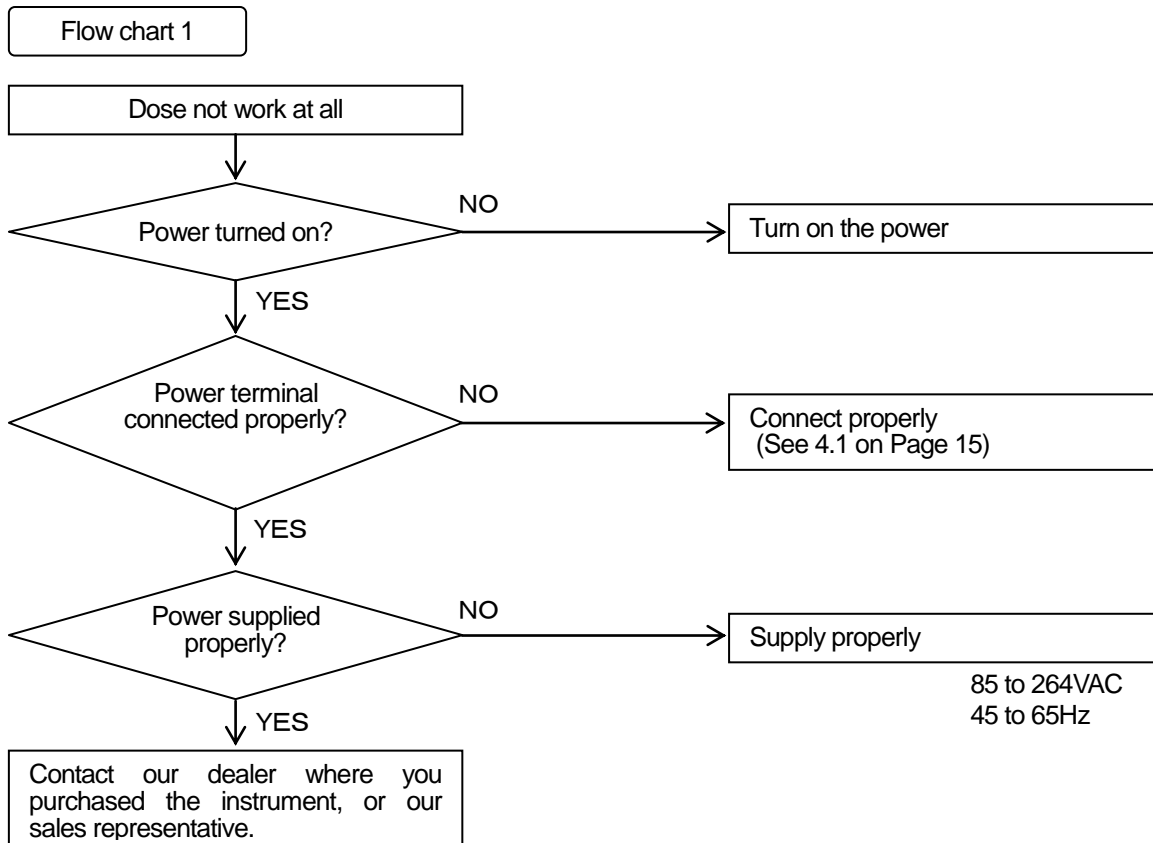

### 10.1.3 When there is a Big Error

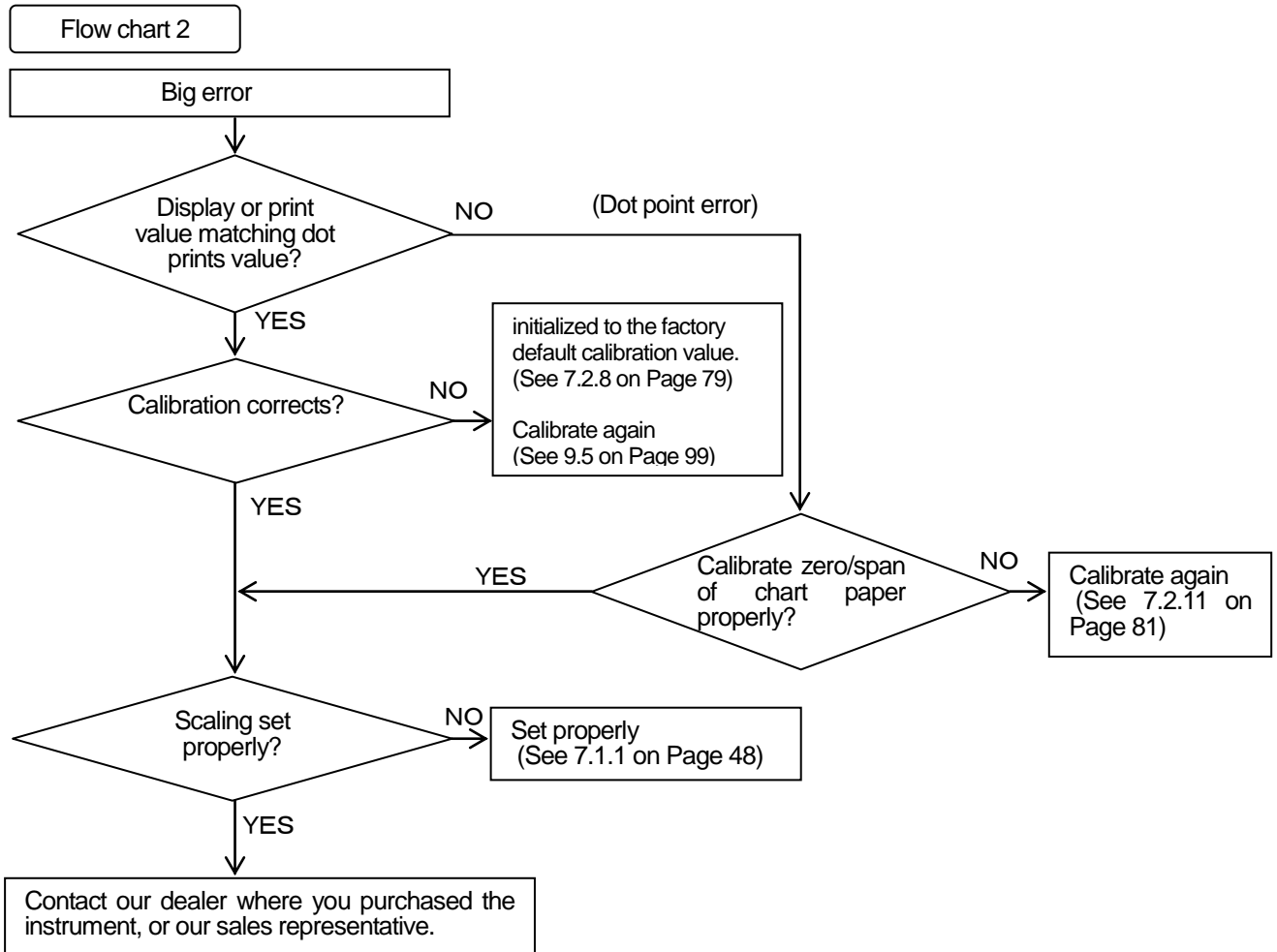

### 10.1.4 When the Trend Recording Deflected

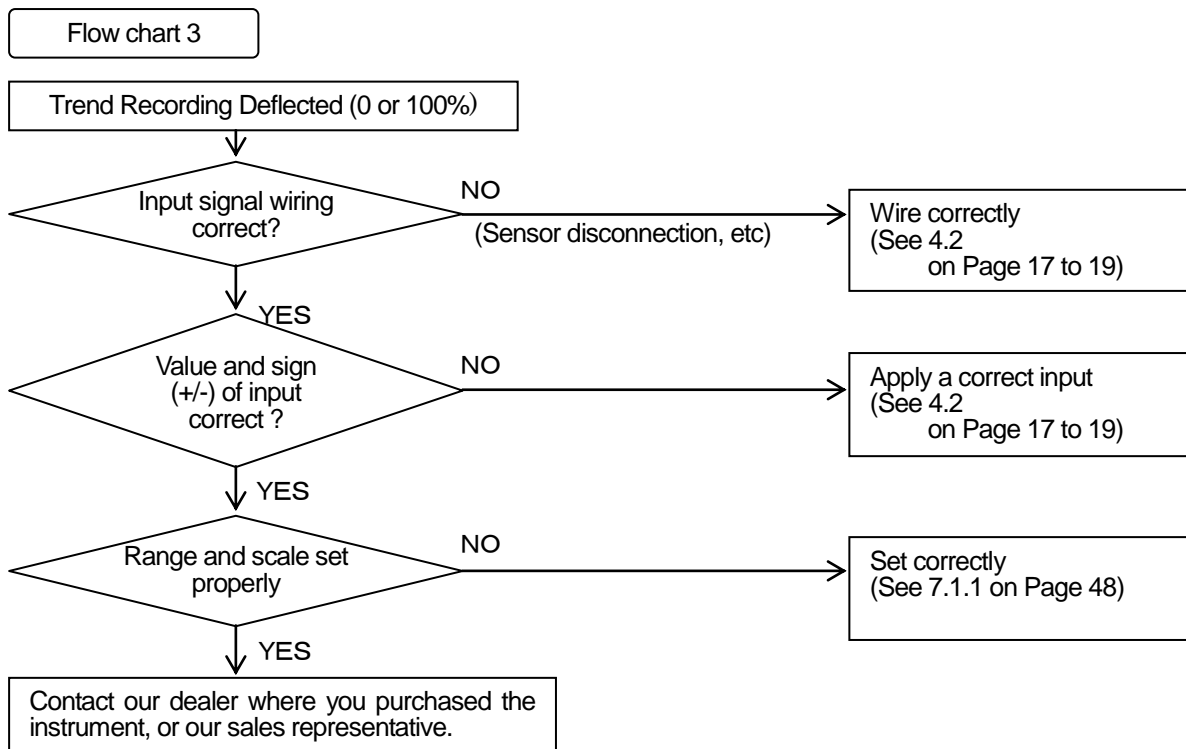



### 10.1.5 When Records Nothing

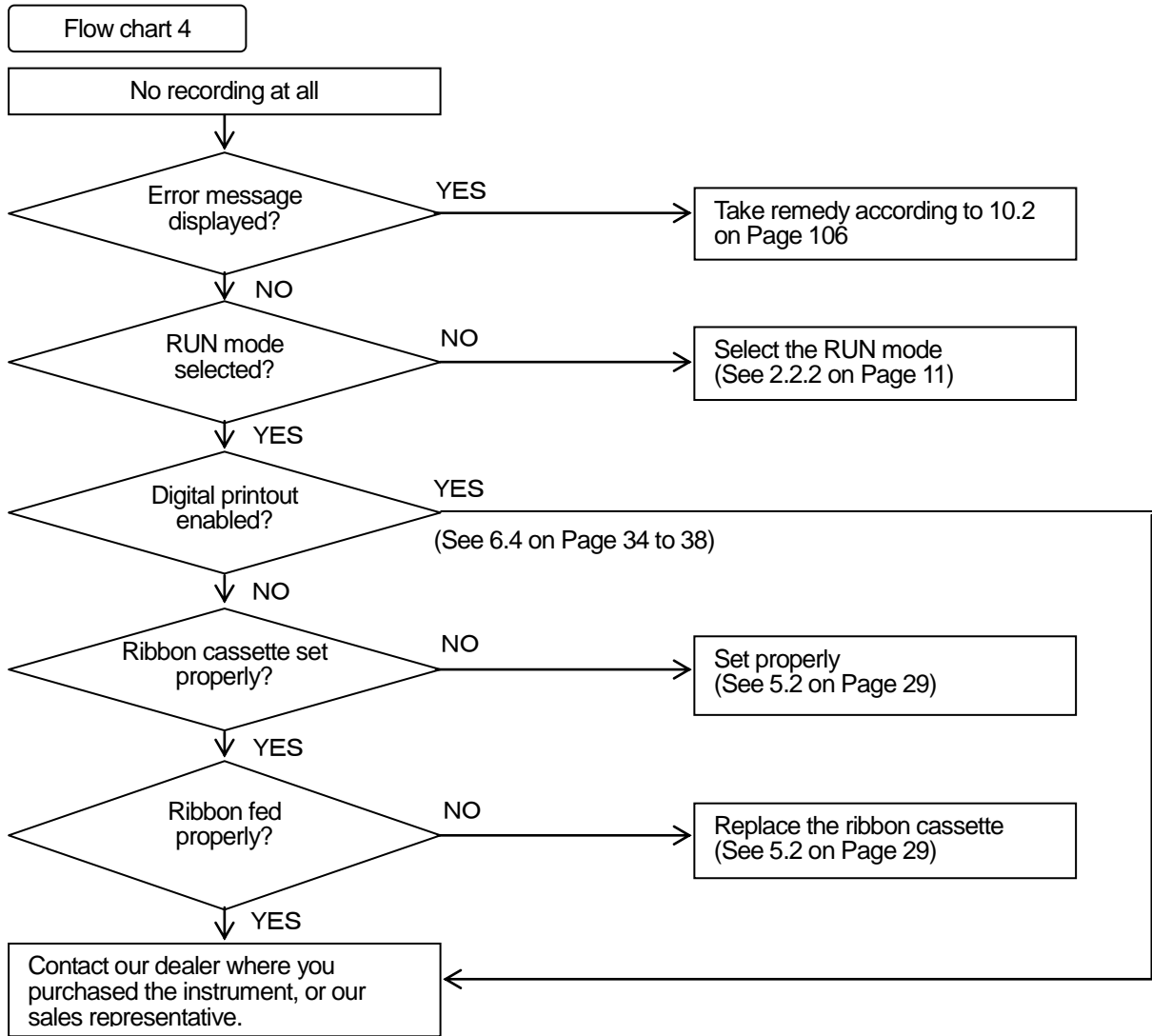

### 10.1.6 When Recording is Faint

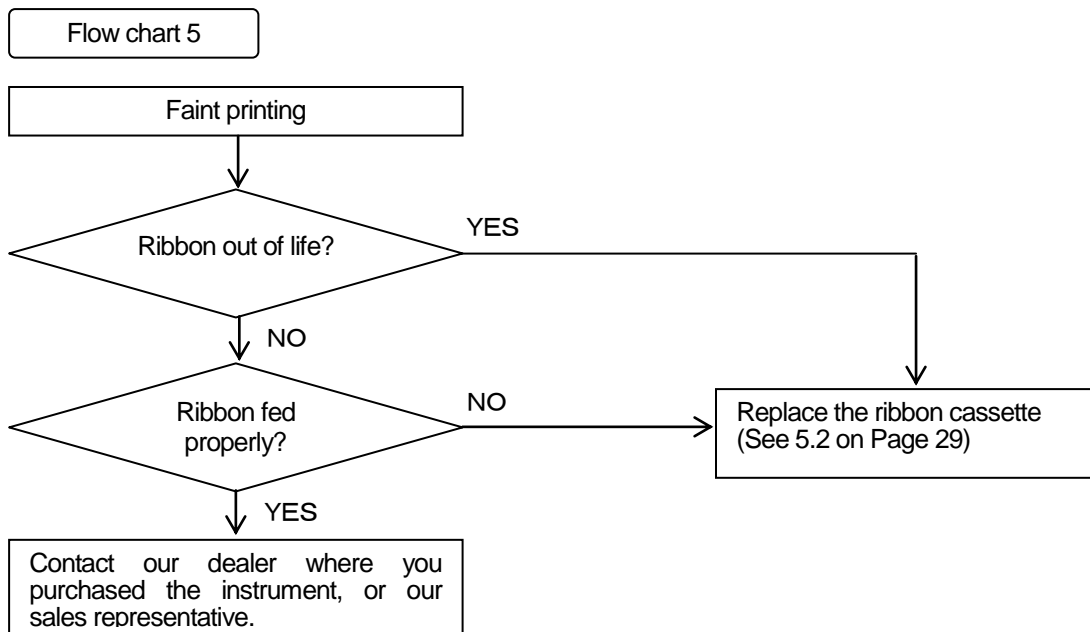

**10.1.7 When the Chart Paper is not fed at All**

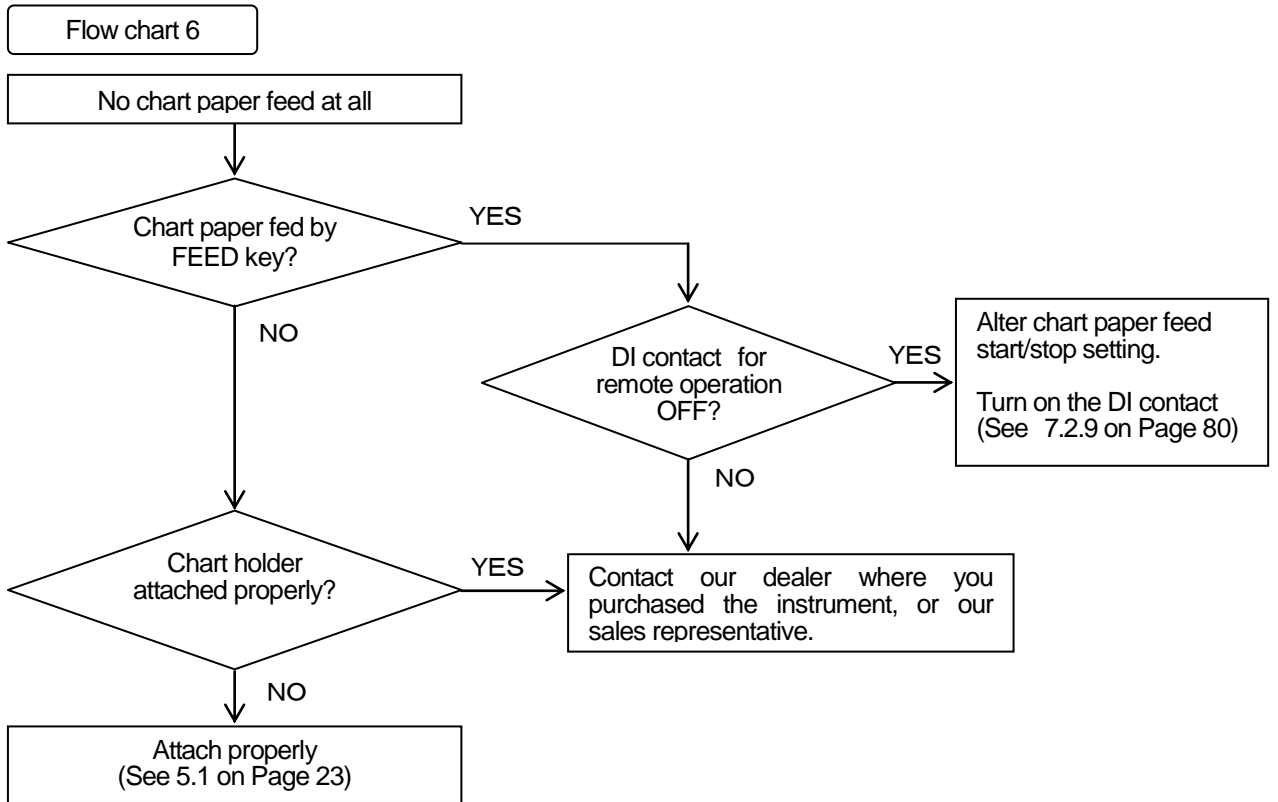

**10.1.8 When the Chart Paper is not fed Properly**

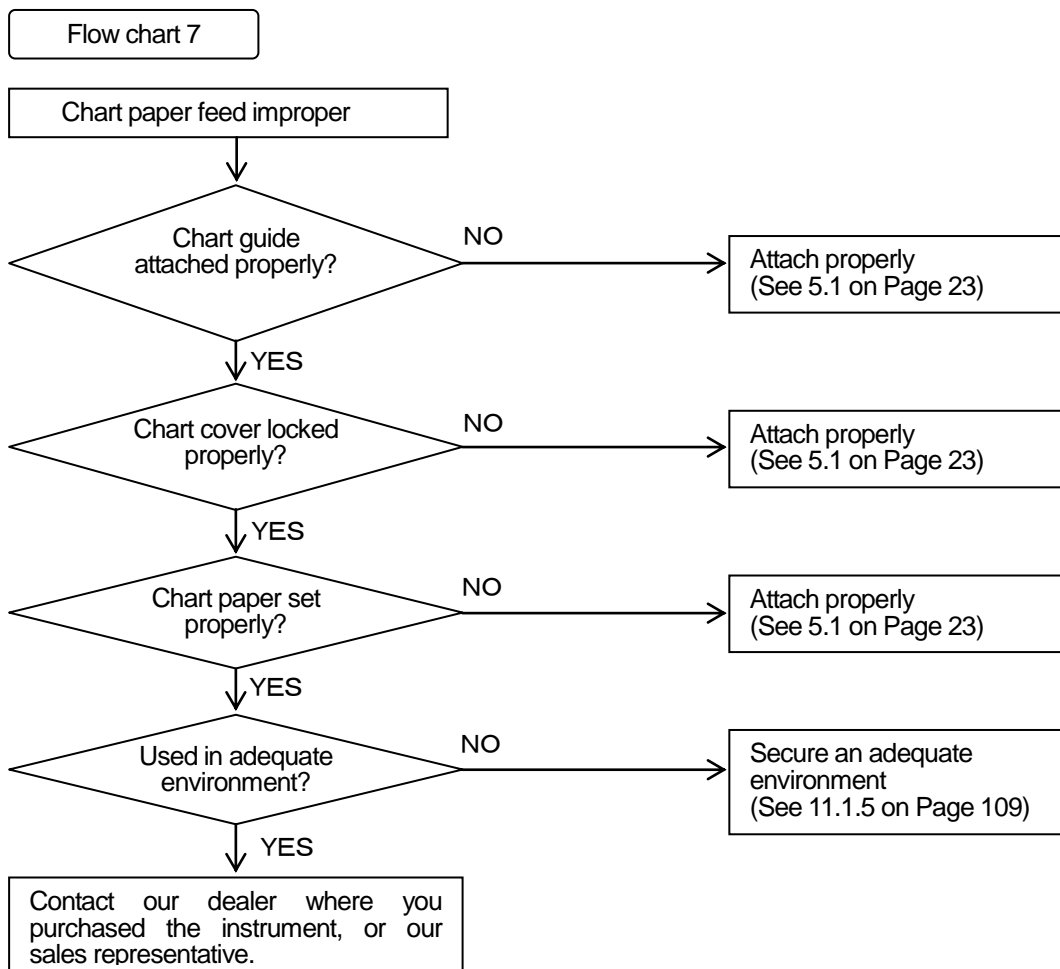

## 10.2 Self Diagnostics Function (ERROR)

This instrument always makes a self diagnostics on the items listed in Table 10.1 below. When an error is found in the self diagnostics results, a relevant error number is displayed.

### 10.2.1 Self Diagnostic Items

**Table 10.1 Status output list**

Type	Error message	Parts	Diagnostic	Remedy
Hard ware error	. . . . .	Zero point sensor	Zero point position of servomotor cannot be detected.	Contact our dealer where you purchased the instrument or our sales representative.
	. . . . .	ADC	AD conversion end error, Initializing error	
	. . . . .	IC for clock	The clock battery runs down [Note1]	
	. . . . .	WDT	Watchdog timer error	
	. . . . .	EEP WRITEWRITE	Non-volatile memory Writing error	
	. . . . .	EEP READ1	Non-volatile memory Reading error (Setup data)	
	. . . . .	EEP READ2	Non-volatile memory Reading error (Engineering data)	
	. . . . .	EEP READ3	Non-volatile memory Reading error (ADC Calibration data)	
	. . . . .	RJC ERROR	The measurement is abnormal of the RJC internal temperature sensor.	
Operation error	. . . . .	Calibration error	Input range error at the calibration of voltage.	Review the input connections, please do the correct calibration.
	. . . . .	Calibration error	Input range error at the calibration of RTD.	
	. . . . .	Area error	Input value is over the setting range.	Set properly
	. . . . .	Time error	Clock time setting error	
	. . . . .	Setting range error	Setting the channel (CH1) which cannot set up the sum/difference/average operation.	
	. . . . .	Area error	Span L $\geq$ Span R	
	. . . . .	Area error	Scale L $\geq$ Scale R	
	. . . . .	Area error	Zone L $\geq$ Zone R or Zone R – Zone L is less than 5mm.	
	. . . . .	Setting channel error	The reference channel range of the sum/difference/average operation is except Volt, TC, RTD and SCALE.	
	. . . . .	All channels skip error	Setting the Skip all channels.	

[Note1] The lifetime of the cell assumes about 10 years but sometimes depends on the use environment.

### 10.2.2 Error Display

- When multiple errors are encountered, their error numbers are displayed with automatic scrolling.
- When an error restores, an error display can be canceled to the input of the “RUN” key.



#### **CAUTION**

While indicates an error, does not indicate Auto, Manual and Date/Time.

# 11. SPECIFICATIONS

## 11.1 Common Specifications

### 11.1.1 Input Signal

- DC voltage :  $\pm 10, 0$  to  $20, 0$  to  $50, \pm 200$  mV DC,  $\pm 1, 0$  to  $5, \pm 10$  V DC
- Thermocouple : B, R, S, K, E, J, T, C, Au-Fe, N, PR40-20, PL II, U, L  
(Thermocouples not to be connected to hazardous voltage or equipment.)
- Resistance temperature detector : Pt100, JPt100
- DC current : 4 to 20mA DC (External shunt resistor:  $250 \Omega$  <charged:HMSU3081A11>)

### 11.1.2 Performance and Characteristics

- Digital accuracy rating : See 11.2.1
- Input impedance :  $10M \Omega$  min. in mV, TC input (without burnout)  
 $200k \Omega$  min. in mV, TC input (with burnout)  
 $1M \Omega$  min. in voltage input  
 $250 \Omega$  (shunt resistance : external <charged:HMSU3081A11>)  
in mA input
- Allowable signal source resistance  
 $10k \Omega$  max. in mV, TC input (without burnout)  
 $100 \Omega$  max. in mV, TC input (with burnout)  
 $1k \Omega$  max. in Voltage input  
 $10 \Omega$  max.(per line) in Resistance temperature detector input
- Normal mode rejection ratio : 60dB min.(50/60 $\pm$ 0.1Hz)
- Common mode rejection ratio : 140dB min.(50/60 $\pm$ 0.1Hz)
- Isolation resistance : 0.5kV DC  $20M \Omega$  min. between the each terminal and grounding terminal
- Withstand Voltage : 1.5kV AC for 1 minute between the power terminal and grounding terminal  
 $0.5kV$  AC for 1 minute between the input terminal and grounding terminal  
 $0.2kV$  AC for 1 minute between the input terminals  
Interchannel maximum noise voltage: 200 V AC at 50/60 Hz
- Vibration resistance : 10 to 60Hz  $1m/s^2$  max.
- Shock resistance :  $2m/s^2$  max.
- Clock precision :  $\pm 50$ ppm max.(At Reference operating conditions)  
The error due to power ON/OFF is not included.
- Chart feed accuracy :  $\pm 0.1\%$  max.

### 11.1.3 Structure

Mounting : Panel mount(vertical panel)  
Allowable backward inclination : Within 30°

Material(Color) : Case ; Polycarbonate(Black), Glass 10% UL94-V0  
Door ; Polycarbonate UL94-V2(Clear)  
; Dust-proof, drip-proof (Complies with the IEC60529-IP65) not evaluated as part of Underwriters Laboratories Listing certification.

### 11.1.4 Power Source

Rated supply voltage range : 100 to 240V AC  
Working supply voltage range : 85 to 264V AC  
Rated power frequency : 50/60Hz  
Working frequency range : 45 to 65Hz

**Table 11.1 Power consumption**

	100VAC	Max. power consumption
6-dot recorder	About 25VA	About 30VA

### 11.1.5 Normal Operating Conditions

Ambient temperature : 0 to 50°C  
Ambient humidity : 20 to 80%RH  
Supply voltage : 85 to 264V AC  
Supply frequency : 45 to 65Hz  
Vibration : 10 to 60Hz 0.2m/s<sup>2</sup> max.  
Shock : Unacceptable  
Magnetic field : 400A/m max. (DC and AC: 50/60Hz)  
Noise : Normal mode(50/60Hz)  
DC current, Thermocouple; Peak value lower than the span width of the measurement range  
Resistance temperature detector ; 50mV max.  
Common mode (50/60Hz) ; 250V AC max.  
Interchannel maximum noise voltage: 200 V AC at 50/60 Hz

Posture : Allowable backward inclination : within 30°, Right-and-left level  
Warming up time : 30 minutes min. from the time of a power-on injection

### 11.1.6 Alarm (Relay Output is Optional)

Outputs	: 6 point (Built-in option, normally open)
Alarm types	: 2 types(H, L), total 4 levels/channel
Contact point capacity	: 250V AC, 3A max. (Resistive load) 30V DC, 3A max. (Resistive load) 125V DC, 0.5A max. (Resistive load)
Hysteresis width	: 0.5%
Setting accuracy	: Digital display accuracy

### 11.1.7 Low Voltage Directive and EMC Directive

Low Voltage Directive	: EN61010-1
EMC Directive	: EN61326-1 Class A
At the EN61000-4-3 test condition:	
DC voltage DC contact range	: Accuracy Ratings + 3digit
Thermocouple range	: Accuracy Ratings + 5digit
Resistance temperature detector range	: Accuracy Ratings + 10digit

### 11.1.8 DI Function (Option)

Set up point is a maximum of 3.

### 11.1.9 Paper-empty Detecting Function (Option)

Detects the Paper-empty to output an alarm.

## 11.2 Standard Setting Specifications

### 11.2.1 Measurement Range

The arbitrary setup is possible by the operation key.

A digital accuracy rating is as Table 11.2 at Reference operating conditions. It is shown below.

Reference operating conditions	: Temperature	; 23 ±2°C
	Humidity	; 55 ±10%RH
	Power source voltage	; 85 to 264V AC
	Electric wave frequency	; 50/60%Hz ±1%
	Warming up time	; 30 minutes min.

The performance in the state where nothing is vibration and a shock.

Terminal block reference junction compensation accuracy is not included in the digital accuracy rating. It is shown below.

Terminal block reference junction compensation accuracy

◇B, R, S, Au-Fe, PR40-20 : ±1°C

◇K, E, J, T, C, N, PL II, U, L : ±0.5°C

**Table 11.2 Measurement Range**

Type	RANGE	Measurement range	Measurement		
			Digital		Analog
			Accuracy	Max. resolution	Accuracy
DC voltage DC contact Input		-10 to 10mV	±(0.2% of rdg + 3digits)	10 μV	
		0 to 20mV	±(0.2% of rdg + 3digits)	10 μV	
		0 to 50mV	±(0.2% of rdg + 2digits)	10 μV	
		-200 to 200mV	±(0.2% of rdg + 3digits)	100 μV	
		-1 to 1V	±(0.1% of rdg + 3digits)	1mV	
		0 to 5V	±(0.2% of rdg + 2digits)	1mV	
		-10 to 10V	±(0.3% of rdg + 3digits)	10mV	
		4 to 20mA	±(0.2% of rdg + 2digits)	0.01mA	
Thermocouple	B	0.0 to 1820.0°C	±(0.15% of rdg + 1°C) 400 to 600°C, ±2°C An accuracy is not compensated within a range of 0 to less than 400°C	0.1°C/0.18°F	Digital accuracy ±(0.3% of span)
		32.0 to 3308.0°F	±(0.15% of rdg + 1.8°F) 752 to 1112°F, ±3.6°F An accuracy is not compensated within a range of 32 to less than 752°F		
	R1	0.0 to 1760.0°C	±(0.15% of rdg + 1°C) ※0 to 100°C, ±3.7°C 100 to 300°C, ±1.5°C		
		32.0 to 3200.0°F	±(0.15% of rdg + 1.8°F) ※32 to 212°F, ±6.7°F 212 to 572°F, ±2.7°F		



Type	RANGE	Measurement range	Measurement		
			Digital		Analog
			Accuracy	Max. resolution	Accuracy
Thermocouple	R2	0.0 to 1200.0°C	±(0.15% of rdg + 0.8°C) ※0 to 100°C, ±3.7°C 100 to 300°C, ±1.5°C	0.1°C/0.18°F	Digital accuracy ±(0.3% of span)
		32.0 to 2192.0°F	±(0.15% of rdg + 1.44°F) ※32 to 212°F, ±6.7°F 212 to 572°F, ±2.7°F		
	S	0.0 to 1760.0°C	±(0.15% of rdg + 1°C) ※0 to 100°C, ±3.7°C 100 to 300°C, ±1.5°C		
		32.0 to 3200.0°F	±(0.15% of rdg + 1.8°F) ※32 to 212°F, ±6.7°F 212 to 572°F, ±2.7°F		
	K1	-200.0 to 1370.0°C	±(0.15% of rdg + 0.7°C) ※-200 to -100°C, ±(0.15% of rdg + 1°C)		
		-328.0 to 2498.0°F	±(0.15% of rdg + 1.3°F) ※-328 to -148°F, ±(0.15% of rdg + 1.8°F)		
	K2	-200.0 to 600.0°C	±(0.15% of rdg + 0.4°C) ※-200 to -100°C, ±(0.15% of rdg + 1°C)		
		-328.0 to 1112.0°F	±(0.15% of rdg + 0.7°F) ※-328 to -148°F, ±(0.15% of rdg + 1.8°F)		
	K3	-200.0 to 300.0°C	±(0.15% of rdg + 0.3°C) ※-200 to -100°C, ±(0.15% of rdg + 1°C)		
		-328.0 to 572.0°F	±(0.15% of rdg + 0.5°F) ※-328 to -148°F, ±(0.15% of rdg + 1.8°F)		
	E1	-200.0 to 800.0°C	±(0.15% of rdg + 0.5°C)		
		-328.0 to 1472.0°F	±(0.15% of rdg + 0.9°F)		
	E2	-200.0 to 300.0°C	±(0.15% of rdg + 0.4°C)		
		-328.0 to 572.0°F	±(0.15% of rdg + 0.7°F)		
	E3	-200.0 to 150.0°C	±(0.15% of rdg + 0.3°C)		
		-328.0 to 302.0°F	±(0.15% of rdg + 0.5°F)		
	J1	-200.0 to 1100.0°C	±(0.15% of rdg + 0.5°C) ※-200 to -100°C, ±(0.15% of rdg + 0.7°C)		
		-328.0 to 2012.0°F	±(0.15% of rdg + 0.9°F) ※-328 to -148°F, ±(0.15% of rdg + 1.3°F)		
	J2	-200.0 to 400.0°C	±(0.15% of rdg + 0.4°C) ※-200 to -100°C, ±(0.15% of rdg + 0.7°C)		
		-328.0 to 752.0°F	±(0.15% of rdg + 0.7°F) ※-328 to -148°F, ±(0.15% of rdg + 1.3°F)		
J3	-200.0 to 200.0°C	±(0.15% of rdg + 0.3°C) ※-200 to -100°C, ±(0.15% of rdg + 0.7°C)			
	-328.0 to 392.0°F	±(0.15% of rdg + 0.5°F) ※-328 to -148°F, ±(0.15% of rdg + 1.3°F)			

Type	RANGE	Measurement range	Measurement		
			Digital		Analog
			Accuracy	Max. resolution	Accuracy
Thermocouple	T1	-200.0 to 400.0°C	±(0.15% of rdg + 0.5°C) ※-200 to -100°C, ±(0.15% of rdg + 0.7°C)	0.1°C/0.18°F	Digital accuracy ±(0.3% of span)
		-328.0 to 752.0°F	±(0.15% of rdg + 0.9°F) ※-328 to -148°F, ±(0.15% of rdg + 1.3°F)		
	T2	-200.0 to 200.0°C	±(0.15% of rdg + 0.4°C) ※-200 to -100°C, ±(0.15% of rdg + 0.7°C)		
		-328.0 to 392.0°F	±(0.15% of rdg + 0.7°F) ※-328 to -148°F, ±(0.15% of rdg + 1.3°F)		
	C	0.0 to 2320.0°C	±(0.15% of rdg + 1°C)	0.1K	
		32.0 to 4208.0°F	±(0.15% of rdg + 1.8°F)		
	Au-Fe	1.0 to 300.0K	±(0.15% of rdg + 1K) ※1 to 20 K, ±2.4 K		
	N	0.0 to 1300.0°C	±(0.15% of rdg + 0.7°C)	0.1°C/0.18°F	
		32.0 to 2372.0°F	±(0.15% of rdg + 1.3°F)		
	PR40-20	0.0 to 1880.0°C	±(0.15% of rdg + 1°C) ※0 to 300°C, ±37.6°C 300 to 800°C, ±18.8°C		
		32.0 to 3416.0°F	±(0.15% of rdg + 1.8°F) ※32 to 572°F, ±67.7°F 572 to 1472°F, ±33.8°F		
	PL II	0.0 to 1390.0°C	±(0.15% of rdg + 0.7°C)		
		32.0 to 2534.0°F	±(0.15% of rdg + 1.3°F)		
	U	-200.0 to 400.0°C	±(0.15% of rdg + 0.5°C) ※-200 to -100°C, ±(0.15% of rdg + 0.7°C)		
-328.0 to 752.0°F		±(0.15% of rdg + 0.9°F) ※-328 to -148°F, ±(0.15% of rdg + 1.3°F)			
L	-200.0 to 900.0°C	±(0.15% of rdg + 0.5°C) ※-200 to -100°C, ±(0.15% of rdg + 0.7°C)			
	-328.0 to 1652.0°F	±(0.15% of rdg + 0.9°F) ※-328 to -148°F, ±(0.15% of rdg + 1.3°F)			
Resistance temperature detector	Pt100-1	-200.0 to 650.0°C	±(0.15% of rdg + 0.3°C)		
		-328.0 to 1202.0°F	±(0.15% of rdg + 0.6°F)		
	Pt100-2	-200.0 to 200.0°C	±(0.15% of rdg + 0.2°C)		
		-328.0 to 392.0°F	±(0.15% of rdg + 0.4°F)		
	JPt100-1	-200.0 to 630.0°C	±(0.15% of rdg + 0.3°C)		
		-328.0 to 1166.0°F	±(0.15% of rdg + 0.6°F)		
JPt100-2	-200.0 to 200.0°C	±(0.15% of rdg + 0.2°C)			
	-328.0 to 392.0°F	±(0.15% of rdg + 0.4°F)			

B,R,S,K,E,J,T,N :JIS C 1602-1995(IEC584-1)  
 C(WRe5-26) :ASTM E988-1996  
 Au-Fe :ASTM E1751-2009  
 PR40-20 :ASTM E1751-2009  
 PL II :ASTM E1751-2009  
 U :DIN43710 :1985(Cu-CuNi)  
 L :DIN43710 :1985(Fe-CuNi)  
 Pt100 :JIS C 1604-1997(IEC751)  
 JPt100 :(JIS C 1604-1981)

## 11.2.2 The Accuracy at the Computation

### (1) Scaling

The accuracy rating at the scaling is as following formula.

$$\text{Scaling accuracy (digits)} = \text{Range accuracy rating (digits)} \times \text{Scaling factor} + 2 \text{ digits}$$

$$\text{But, Scaling factor} = \frac{\text{Scaling span (digits)}}{\text{Measurement range span (digits)}}$$

Example 1) When VOLT range is  $-1.000 \sim 1.000\text{V}$  and Scaling range is  $0.00 \sim 100.00$ .

$$\text{Range accuracy rating} = 0.1\% \times 1.000\text{V} + 3 \text{ digits}$$

$$\text{(Input } +1.000\text{V)} = 4 \text{ digits}$$

$$\text{Scaling factor} = \frac{10000 - 0}{1000 - (-1000)}$$

$$\begin{aligned} \text{Therefore, Scaling accuracy} &= \pm(4 \times 5 + 2) \\ &= \pm 22 \text{ digits} \end{aligned}$$

$$\begin{aligned} \text{Analog recording accuracy} &= \pm \left[ 4 + \{1000 - (-1000)\} \times \frac{0.3}{100} \right] \\ &= \pm 10 \text{ digits} \\ &= \pm 0.01\text{V} \end{aligned}$$

Example 2) When Type K is  $0.0 \sim 200.0^\circ\text{C}$  and Scaling is  $0.00 \sim 200.00$ .

$$\text{Range accuracy rating} = 0.15\% \times 200.0 + 0.3^\circ\text{C}$$

$$\text{(Input } 200^\circ\text{C)} = 0.6^\circ\text{C}$$

$$= 6 \text{ digits}$$

$$\text{Scaling factor} = \frac{20000 - 0}{2000 - 0}$$

$$\begin{aligned} \text{Therefore, Scaling accuracy} &= \pm(6 \times 10 + 2) \\ &= \pm 62 \text{ digits} \\ &= \pm 0.62^\circ\text{C} \end{aligned}$$

### (2) Square root computation

The square root computation is as following formula.

$$\text{Display value} = 10 \sqrt{\text{Process variable}}$$

Display value accuracy rating:  $\mathcal{E}$ , Process variable accuracy:  $e$ , and Process variable:  $x$  (convert into %).

$$\text{Display value} = 10 \sqrt{x \pm e} \doteq 10 \sqrt{x} \pm \frac{10e}{2\sqrt{x}}$$

$$\text{Therefore, Display value accuracy } \mathcal{E} = \frac{5e}{\sqrt{x}}$$

When input 4~20mA, the square root computation accuracy:  $\epsilon$  is as following formula.

$$\text{Measuring 100\%} \quad \epsilon_{100} = \frac{5e}{\sqrt{100}} = \frac{5(0.2+0.125)10}{\sqrt{100}} = 0.16\% \text{ rdg}$$

$$\text{Measuring 50\%} \quad \epsilon_{50} = \frac{5e}{\sqrt{50}} = \frac{5(0.1+0.167)}{7.07} = 0.19\% \text{ rdg}$$

$$\text{Measuring 9\%} \quad \epsilon_9 = \frac{5e}{\sqrt{9}} = \frac{5(0.018+1.39)}{3} = 2.3\% \text{ rdg}$$

$$\text{Measuring 1\%} \quad \epsilon_1 = \frac{5e}{\sqrt{1}} = 5(0.002+12.5) = 62.5\% \text{ rdg}$$

If the process variable is low as above, its accuracy rating is incorrect.

### **(3) Decade**

The accuracy rating at the decade computation is defined the logarithm of display value. Normally, the accuracy rating is less than 1 digit and you cannot read by significant digit.

### **(4) Difference, Sum, and Average**

The accuracy rating of Difference, Sum, and Average is as following formula.

Difference and Sum : Reference channel accuracy rating  $\times 2$

Average : Reference channel accuracy rating

Example) When Reference channel VOLT is 00.00~10.00V and Difference is -10.00~10.00.

$$\begin{aligned} \text{Reference channel accuracy rating} &= \pm (0.3\% \times 10.00V + 3 \text{ digits}) \\ &= \pm (1000 \times 0.003 + 3) \\ &= \pm 6 \text{ digits} \end{aligned}$$

$$\text{Difference accuracy rating} = \pm 6 \times 2 = \pm 12 \text{ digits}$$

### 11.2.3 Individual Specifications

**Table 11.3 Specification Items**

Block	Item	Specification
Input Unit	Measuring Point	6
	Input Sampling	10s/6CH
	Display Interval	2.5s
Record & Printer	Recording Form	Wire dot (6-color ink ribbon)
	Printing Form	
	Recording Width	100mm
	Print Period	10s/6CH [Note 1]
	Chart paper	Length : 16m, Width : 114mm, Folding width : 40mm The length of the Clean Chart is 12 m.
	Chart speed	0, 1, 2, 3, 4, 5, 10, 15, 20, 25, 30, 40, 50, 60, 75, 80, 90, 100, 120, 150, 160, 180, 200, 240, 300, 360, 375, 450, 600, 720, 750, 900, 1200, 1500mm/h (Analog recording is not done during the chart speed setting 0mm/h.)
	Recording color	No.1(Purple), No.2(Red), No.3(Green), No.4(Blue), No.5(Brown), No.6(Black) [Note 2]
Printing color	Purple, Red, Green, Blue, Brown, Black	
Weight		1.5kg max.
Power consumption		30VA max.

[Note 1] Select the Dot Point Interval from 10, 20, 30 and 60 seconds for the setting.

[Note 2] Change in arbitrary colors in possible by setup.

## 11.2.4 Standard Functions

**Table 11.4 Standard Functions**

Item	Description
Analog indication	None
Analog recording	Makes analog recording with 6-color dot.
Engineering unit indication	None
Digital display	Indicates Channel No., Process variable data, Chart speed, Alarm setting value on the display.
Logging print	Prints Date, Time, Scaling, Chart speed, Process variable and Engineering unit at a programmed interval. With the setting, it is possible for the synchronous print/Asynchronous print to choose.
List print	Prints Chart speed, Sensor type, Measurement range, Engineering unit, Alarm setting value, Comment, Printing description, Logging print ON/OFF, Zone, Partial Compression/Expansion
Engineering list print	Prints Channel or Tag, Alarm function, Logging print ON/OFF, Reference time, Interval, Scaling print ON/OFF, Logging print Sync./Async., Alarm hysteresis, Burn out, DI function(Optional)
Affix print	Prints Channel number by the analog recording.
Manual print	Prints Measurement result by key input. Analog recording stops.
Dot print skip	Skips recording of an unused channel.
Programming	Programs Chart speed, Alarm setting value, Logging, Dot point skip, Date and Time.
Memory back up	A built-in lithium battery protects the clock function. The battery life is 10 years. (total power off period of the instrument : 5 years) A non-volatile memory stores setting data and calibration data.
Alarm	Sets 2 types (H, L) of alarms per channel. Sets a total of 4 level.
Chart speed	Selects Chart speed from 34 types.
Clock indication	Indicates Year, Month, Day, Hour and Minute. Sets the year in A.D, and adjusts leap year automatically.
Self diagnostics	Occurring some type of the defect to indicate "E Err * *". (* * : type of the defect)
Scaling	Indicates and record the input of a unification signal etc. is changed into the engineering scales.

## 11.3 Standard Setting Functions

### 11.3.1 Standard Setting Functions

**Table 11.5 Standard Setting Functions**

Function	Description
Burnout	To deflect over toward 100% with disconnecting input. Specifies the every channel's burnout. (DC voltage of $\pm 50\text{mV}$ max., TC input)
Tag Number	Sets a tag number by 7 figures every channel. (Prints at a logging print)
Reference Junction Compensation	Specifies an inside/outside of the Reference Junction Compensation.
Copy Function	Copies a channel setting up.
Setting input offset	Setting input offset is possible for every channel.
Zone Recording (Track Recording)	Specifies a recording area every channel to separate into Tracks.
Partial compression/expansion	Records Partial Compression/Expansion to 1-crease line every channel.
Decade Recording Indication	Records and indicates by 5 decades. It is 2 figures that the effective number to indicate and print.
Alarm Print	Prints Occurrence time, Occurrence channel, Setting No. and Alarm type in purple at occurring an alarm.
Alarm Recovery Print	Prints Recovery time, Recovery channel, Setting No. and Alarm type in purple at recovering an alarm.
Record Start/End Print	Prints time and comment ("Start" or "End") when record beginning or end.
Computation	Computes Square root.
Interchannel Computation	Computes Sum, Difference and Average computation.
Alarm Hysteresis Width	Sets an alarm hysteresis width 0% FS or 0.5% FS.

## 11.4 Optional Functions

### 11.4.1 Remote Function of DI

Function	Description
Chart Feed Start/Stop	Starts with turning to ON. Stops with turning to OFF.
Changing Chart Speed	Changes 1st with turning to ON and 2nd with OFF.
Comment Print (Sync./Async.)	Prints Comment with turning to ON.
Manual Print (Sync./Async.)	Prints Manual Print with turning to ON.
Date and Time Print (Sync./Async.)	Prints Date and Time with turning to ON.

### 11.4.2 Alarm Board

6 relays

### 11.4.3 Communication unit

RS-232C(Standard)

RS-485(option)

# Custom Manufacturer Since 1972

ELECTRIC HEATING ELEMENTS • TEMPERATURE CONTROLS • SENSORS • PROCESS HEATING SYSTEMS

## HEAT THINGS UP!

With Thousands of Design Variations  
We Make Everything You Need.

Band Heaters	Cartridge Heaters
Cast-In Heaters	Coil & Cable Heaters
Radiant Heaters	Strip Heaters
Flexible Heaters	Tubular Heaters
Process Heaters	Instrumentation
Temperature Control	Temperature Sensors



607 N. Central Avenue Wood Dale, IL 60191-1452 USA  
P: 630-350-2252 Toll Free: 800-323-6859  
F: 630-350-0232 E: [info@tempco.com](mailto:info@tempco.com)  
[www.tempco.com](http://www.tempco.com)